



## **2003 Rear Shock Owner's Manual**

FLOAT - FLOAT R - FLOAT L - FLOAT RL

Vanilla - Vanilla R - Vanilla RL - Vanilla RC

AVA - TALAS - SBC Enduro - SBC Epic - M-BITS

### **FOX RACING SHOX**

130 Hangar Way, Watsonville, CA 95076

831.768.1100 FAX 831.768.9342

E-Mail: [service@foxracingshox.com](mailto:service@foxracingshox.com)

Website: [www.foxracingshox.com](http://www.foxracingshox.com)

## Table of Contents

<b>Introduction</b> .....	3
<b>General Information</b>	
Contact Info .....	3
Method of Shipping .....	3
Methods of Payment .....	3
Service / Warranty .....	3
International Service Centers .....	3
Warranty Policy .....	4
Disclaimer .....	4
Consumer Safety .....	5
Shock Terminology .....	5
<b>General Set-Up Instructions</b>	
Measuring Sag .....	6
General Maintenance .....	6
<b>FLOAT Shocks</b>	
Pump .....	7
Adjusting Sag .....	8
FLOAT Drawing & Features .....	8
FLOAT R Drawing & Features .....	9
Rebound Adjustment .....	9
FLOAT L Drawing & Features .....	9
Compression Adjustment .....	9
FLOAT RL Drawing & Features .....	10
SBC Enduro FLOAT R & RL .....	10
Air Volume Adjuster - AVA .....	11
Travel Adjust Linear Air Spring - TALAS .....	11
Air Sleeve Maintenance .....	12
SBC Epic BRAIN FLOAT R .....	13
Remote Lockout .....	14
<b>Vanilla Shocks</b>	
Adjusting Sag .....	15
Installing and Removing Springs .....	15
Vanilla Drawing & Features .....	16
Vanilla R Drawings & Features .....	16
Rebound Adjustment .....	16
Vanilla RL Drawing & Features .....	17
Compression Adjustment .....	17
Vanilla RC Drawing & Features .....	17
Compression Adjustment .....	17
<b>M-BITS by FOX Racing Shox</b>	
Klein & Seven Cycles M-BITS .....	18
<b>International Versions</b>	
Français .....	19
Italiano .....	37
Deutsch .....	55
Español .....	73
Japanese .....	91

## Introduction

Thank you for choosing FOX Racing Shox for your bicycle. In doing so, you have chosen the number one shock absorber in the industry! All FOX Racing Shox products are designed, manufactured and assembled by the finest professionals in the industry. As a consumer and supporter of FOX Racing Shox products, you need to be aware of the importance of setting up your new shock correctly to ensure maximum performance. This manual will provide you with the step-by-step instructions of how to set up your shock. It is a good idea to keep your receipts with this manual and refer to it for service and warranty issues.

## General Information

### Contact Info

FOX Racing Shox Phone: 831.768.1100 E-mail: [service@foxracingshox.com](mailto:service@foxracingshox.com)  
130 Hangar Way North America: 800.369.7469 Website: [www.foxracingshox.com](http://www.foxracingshox.com)  
Watsonville, CA 95076 Fax: 831.768.9312 Business Hours: Monday-Friday 8:00AM-5:00PM Pacific Time

### Shipping Method

We use UPS ground service within the USA.

### Method of Payment

Visa, MasterCard,  
Cashier's Check

### Service/Warranty

FOX Racing Shox USA is pleased to offer 48-hour\* turnaround for product service, provided the following steps are taken.

1. Contact FOX Racing Shox at 831.768.1100 or Authorized Service Center to obtain a Return Authorization Number (R.A. number) and shipping address. For Authorized Service Centers, please refer to the list below, contact FOX Racing Shox or go to [www.foxracingshox.com](http://www.foxracingshox.com) to determine the Service Center nearest you.

2. Satisfactory proof of purchase receipt is required for warranty consideration.

3. Mark the R.A. number and the Return Address clearly on the outside of the package and send the item(s) to FOX Racing Shox or your Authorized Service Center with shipping charges pre-paid by sender.

4. Include a description of the problem, bicycle information (manufacturer, year and model), type of FOX Racing Shox product, spring rate and return address with daytime phone number.

\*Authorized Service Centers operate independently. Service and Warranty turnaround times may vary.

<b>Australia</b> Dirt Works 011 612-9679-8400 <a href="mailto:dirtworks@dirtworks.com.au">dirtworks@dirtworks.com.au</a>	<b>Germany</b> Shock Therapy 011 49 6126 226770 <a href="mailto:support@shock-therapy.com">support@shock-therapy.com</a>	<b>Philippines</b> Dan's Bike Shop 011 63 34 435 3633 <a href="mailto:dansbike@WBl.ph">dansbike@WBl.ph</a>
<b>Belgium</b> Sabma 011 32 87-631980 <a href="mailto:sabma@skynet.be">sabma@skynet.be</a>	<b>Germany</b> Toxoholic's 49 6331-258160 <a href="mailto:toxoholics@t-online.de">toxoholics@t-online.de</a>	<b>Spain</b> Dirt Racing 011 34-91-663-71-25 <a href="mailto:mrojo.dirt@nexo.es">mrojo.dirt@nexo.es</a>
<b>Brazil</b> Plimax 2 Fast 011 5511-251-0633 <a href="mailto:astec@plimax.com">astec@plimax.com</a>	<b>Israel</b> DAA Sport Marketing 972-(0)9-865-6960 <a href="mailto:dan@daa.co.il">dan@daa.co.il</a>	<b>Switzerland</b> FOX Racing Shox Europe 011 41-31-809-30-20 <a href="mailto:frs-europe@bluewin.ch">frs-europe@bluewin.ch</a>
<b>Canada (West)</b> Cycle Works 780 440-3200 <a href="mailto:mail@cycleworks.com">mail@cycleworks.com</a>	<b>Italy</b> Pepi Innerhofer 011-39-0473-56-3107 <a href="mailto:info@pepi.it">info@pepi.it</a>	<b>Thailand</b> Uniwave Limited & UWC Co. Ltd. 011 66 2 367 3470 <a href="mailto:kanate@uniwave.net">kanate@uniwave.net</a>
<b>Canada (East)</b> Velocycle, Inc. 514 849 5299 <a href="mailto:velocycle@primus.ca">velocycle@primus.ca</a>	<b>Japan</b> Mom & Pop's 011 81-586-43-6810 <a href="mailto:mamapapa@mtg.biglobe.ne.jp">mamapapa@mtg.biglobe.ne.jp</a>	<b>The Netherlands</b> Cannondale Europe BV 011 315 4158 9898 <a href="mailto:repair@cannondale.com">repair@cannondale.com</a>
<b>Czech Republic</b> Racebike 00420 653 66 12 40 <a href="mailto:rb@racebike.cz">rb@racebike.cz</a>	<b>Korea</b> Xenon Sports International 011-82-31-555-0077 <a href="mailto:xenon@netsgo.com">xenon@netsgo.com</a>	<b>United Kingdom</b> Mojo Suspension 011 44-1633-615-815 <a href="mailto:chris@mojo.co.uk">chris@mojo.co.uk</a>
<b>France</b> FMF Sport Group 011 33-494-541950 <a href="mailto:fmfsportgroup@wanadoo.fr">fmfsportgroup@wanadoo.fr</a>	<b>New Zealand</b> Blue Shark Enterprises 011 64-4-589-4535 <a href="mailto:alastair@mountainbikes.co.nz">alastair@mountainbikes.co.nz</a>	<b>United States</b> FOX Racing Shox 831-768-1100 <a href="mailto:service@foxracingshox.com">service@foxracingshox.com</a>

## Warranty Policy

The factory warranty period for your shock is one year from the original date of purchase of the bicycle or shock. A copy of the original purchase receipt must accompany any shock being considered for warranty service. Warranty is at the full discretion of FOX Racing Shox and will cover only defective materials and workmanship. Warranty duration and laws may vary from state to state and/or country to country.

**FLOAT, FLOAT R, FLOAT L, FLOAT RL Warranty:** To maintain high performance, product longevity, and preserve warranty rights, periodic end user maintenance is required. (See the Maintenance Schedule for further instructions)

To ensure peak performance, repairs and service to the shock must be performed by FOX Racing Shox in the USA or outside the USA by a FOX Racing Shox Authorized Service Center.

Parts, components and assemblies subject to normal wear and tear are not covered under this warranty.

**FOX Racing Shox reserves the right to all final warranty or non-warranty decisions.**

**General exclusions from this warranty shall include but are not limited to any failures caused by:**

Installation of parts or accessories that are not qualitatively equivalent to genuine FOX Racing Shox parts.

Abnormal strain, neglect, abuse and/or misuse.

Accident or collision damage.

Modification of original parts.

Lack of proper maintenance. (very important - see Maintenance Schedule)

Any attempt to disassemble damper assembly.

Shipping damages or loss (purchase of full value insurance is recommended).

Damage to interior or exterior caused by improper cable routing, seatpost, rocks, crashes or improper installation.

Oil changes or service not performed by FOX Racing Shox or an Authorized Service Center.

Coil bind / Excessive spring preload (two turns maximum).

**Specific exclusions from this warranty shall include:**

Parts replaced due to normal wear and tear and/or routine maintenance.

Parts subject to normal wear and tear and/or routine maintenance:

Bushings and reducers

Seals

Suspension fluids

FOX Racing Shox makes no other warranty of any kind, expressed or implied. All implied warranties of merchantability and fitness for a particular purpose which exceed the obligations and time limits stated in this warranty are hereby disclaimed by FOX Racing Shox and excluded from this warranty.

## Warranty Q & A

Q. What costs are my responsibility during the warranty period?

A. The customer is responsible for all costs of maintenance services, non-warranty repairs, accident and collision damages, oil, seals, bushings and reducers, and mounting hardware.

Q. What are some examples of "abnormal" strain, neglect or abuse?

A. These terms are general and overlap each other in areas. Specific examples are: Hucking, ghost riding, big drop, stunt / dare-devil riding, riding with broken parts, riding without oil in shock, too much preload, wrong spring rate, etc.

Q. Does the warranty cover incidental costs such as shipping or transportation?

A. No. The warranty is limited to repair of materials and/or workmanship.

Q. May I perform any or all of the recommended maintenance shown in the owner's manual?

A. You may perform FLOAT Air Sleeve, bushing and reducer maintenance only. Oil changes, damper service and repairs must be performed by FOX Racing Shox or an Authorized Service Center.

## Disclaimer

FOX Racing Shox is not responsible for any damages to you or others arising from riding, transporting, or other use of your shock or bicycle. In the event that your shock breaks or malfunctions, FOX Racing Shox shall have no liability or obligation beyond the repair or replacement of your shock, pursuant to the terms outlined in the warranty provisions of this manual.

## **Consumer Safety**

RIDING A BICYCLE IS DANGEROUS AND CAN RESULT IN DEATH OR SERIOUS INJURY. TAKE YOUR RESPONSIBILITY TO YOURSELF AND OTHERS SERIOUSLY.

- Maintain your bicycle and suspension
- Wear protective clothing, eye protection and a helmet
- Ride within your limits
- Tread lightly

Your bike is equipped with FOX Racing Shox rear suspension. Before riding, take the time to read the FOX Racing Shox manual on set-up, use, and service of your shock. If you have questions, contact your Authorized FOX Racing Shox Service Center or call FOX Racing Shox directly at 831.768.1100.

If your shock ever loses oil, or if it makes unusual noise, stop riding immediately and have the shock inspected by a dealer, Service Center or contact Fox Racing Shox. RIDING WITH A BROKEN OR MALFUNCTIONING SHOCK CAN RESULT IN LOSS OF CONTROL, CRASHING, AND POSSIBLE DEATH OR SERIOUS INJURY.

Never modify your bike frame or shock. Only use genuine Fox Racing Shox parts for your shock. Any modification, improper service, or use of after-market replacement parts will void the warranty and could damage the shock or cause loss of control of the bike resulting in serious injury or death.

Follow the scheduled maintenance recommendations in this Manual. Always have your shock serviced by Fox Racing Shox in the USA or an Authorized FOX Racing Shox Service Center outside the USA.

**YOUR FOX Racing Shox IS PRESSURIZED WITH NITROGEN. DO NOT EVER PRY OUT THE WHITE NYLON (PLASTIC) PLUG AT THE EYELET END OF SHOCK.**

**THE CHARGED PORTION OF THE SHOCK SHOULD NEVER BE OPENED EXCEPT BY AN AUTHORIZED SERVICE CENTER.**

**IF YOU HAVE AN AIR SHOCK (FLOAT), THE PORTION OF THE SHOCK THAT IS CHARGED WITH NITROGEN DOES NOT NEED TO BE OPENED IN ORDER TO PERFORM CLEANING AND LUBRICATION OF THE AIR SLEEVE CHAMBER.**

**OPENING A NITROGEN PRESSURIZED SHOCK CAN BE DANGEROUS AND CAN RESULT IN INJURY. DO NOT DO IT.**

**WARNING: DO NOT ATTEMPT TO PULL APART, OPEN, DISASSEMBLE OR SERVICE A SHOCK IF IT IS COMPRESSED OR HAS NOT RETURNED (WILL NOT RETURN) TO ITS ORIGINAL NEUTRAL LENGTH (WITH NO LOAD ON THE SHOCK). SERIOUS INJURY CAN RESULT.**

## **Shock Terminology**

**Shock Sag:** The amount the shock compresses with the rider on the bicycle in a normal riding position.

**Compression Damping:** The oil damping resistance felt when trying to compress the shock.

**Rebound Damping:** The oil damping resistance which controls the rate at which the shock will extend.

**Preload:** The initial amount of force placed on a spring.

**Spring Rate:** The force needed to compress a spring on inch.

**FLOAT:** The acronym for FOX Load Optimum Air Technology which delivers the performance of a coil spring with the adjustability and light weight of an air shock.

**Vanilla:** Coil spring technology specific to FOX which offers the utmost in bump performance and sets the standard against which all other technologies are measured.

## General Set-Up Instructions

### Measuring Sag

To get the best performance from your FOX Racing Shox, it is necessary to adjust sag. Sag is how much the shock compresses or “sags” when you sit on the bicycle.

Use this procedure to measure the sag on your FOX Racing Shox FLOAT and Vanilla shocks.

#### Measurement #1

1. Before sitting on the bicycle, measure and record the distance from the center of one mounting bolt to the center of the other mounting bolt. This is known as the “eye to eye” measurement.

#### Measurement #2

2. Sit on the bicycle in a normal riding position. Your weight should be distributed on the saddle and pedals. It may be necessary to hold yourself up against a wall or post to steady yourself. Do not bounce on the pedals or saddle.

3. Have an assistant measure and record the eye to eye distance.

Subtract Measurement #2 from Measurement #1. The difference is the sag.

## General Maintenance

### Maintenance Schedule

Item	New	Every ride	Every 8 hours	Every 40 hours	Every 1000 hours
Set sag (All shocks)	X				
Set rebound (All shocks w/rebound adjust)	X				
Clean shock body (All shocks)		X			
Air sleeve maintenance (FLOAT shocks only) Wet & muddy conditions			X		
Dry & dusty conditions				X	
Clean & inspect bushings & reducers (All shocks)				X	
Suspension fluid service (All shocks-must be performed by Service Center)					X

### Other Maintenance Considerations

On FLOAT shocks there may be a small amount of air sleeve lubricant residue on the body. This is normal. If this residual air sleeve lubricant is not present, this is an indication that the FLOAT air sleeve should be re-lubed.

If you ride in extreme conditions, service your shock more frequently.

Wash your shock with soap and water ONLY.

**DO NOT USE A HIGH PRESSURE WASHER ON YOUR SHOCK!**

**Extensive internal service should be performed by FOX Racing Shox or an Authorized FOX Racing Shox Service Center.**

## FLOAT Shocks

### Pump

A FOX Racing Shox high pressure air pump is available for your FLOAT shock. It is used to add and release air pressure from your FLOAT shock. FOX Racing Shox part number is 027-00-001-A.



Remove the air valve cap from the shock.

Thread the pump's valve chuck onto the shock's air valve until pressure registers on the pump gauge. This takes approximately 6 turns. Do not over-tighten pump on air valve as this will damage the pump chuck seal.

Stroke the pump a few cycles. The pressure should increase slowly. If pressure increases rapidly check to make sure the pump is properly fitted and tightened onto the air valve.

Note: If shock has no air pressure, the gauge will not register pressure.

Pump to desired pressure setting. You can decrease pressure by pushing the black bleed valve. Pushing the bleed valve half way down, and holding it there, will allow pressure to escape from the pump and shock. Pushing the bleed valve all the way down and releasing it will allow only a small amount of pressure to escape (micro adjust). When unthreading the pump from the air valve fitting, the sound of the air loss is from the pump hose, not the shock itself.

Note: When you attach the pump to the shock, the hose will need to fill with air. This will result in a lower pressure registering approximately 10 to 20 PSI on the gauge.

Note: Average setting range is from 50 to 300 PSI. DO NOT EXCEED 300 PSI.  
Replace the air valve cap before riding.

**Warning: If your FLOAT shock has not returned to its original neutral length (eye to eye position), DO NOT attempt to disassemble the outer air sleeve or any other part of the shock. Air has become trapped in the Air Negative chamber and can cause serious injury if the shock is disassembled. This condition is known as "stuck down". If the shock is stuck down, return it immediately to FOX Racing Shox or an Authorized FOX Racing Shox Service Center for service. (see Service / Warranty for details)**

Procedure to check for a stuck down shock:

1. Release air pressure from the shock.
2. Using a FOX Racing Shox high pressure pump, pressurize the shock to 250 psi.
3. If the shock does not extend it has become stuck down.

**DO NOT ATTEMPT TO PULL APART, OPEN, DISASSEMBLE OR SERVICE A SHOCK THAT IS STUCK DOWN. SERIOUS INJURY CAN RESULT. Contact FOX Racing Shox or an Authorized FOX Racing Shox Service Center for assistance.**

Note: While a "stuck down" shock is a serious condition and should only be serviced by FOX Racing Shox or an Authorized FOX Racing Shox Service Center, it is also rare.

## Adjusting Sag

To get the best performance from your FLOAT shock, it is necessary to adjust sag. On your FLOAT shock this is done by adjusting the air pressure. The air pressure needed is determined by the rider's weight and riding conditions. Sag is how much the shock compresses when you sit on the bicycle. Increasing air pressure will make the shock stiffer. Decreasing the air pressure will make the shock softer. (Note: It might be necessary to change air pressure to achieve the proper sag setting). The smoothest ride will be attained by running the air pressure low enough to occasionally bottom out.

1. Locate the Schrader air valve on the shock and remove the valve cap.
2. Screw your FOX Racing Shox pump onto the air valve until the pump shows pressure on the gauge. Do not over tighten.
3. Add air pressure by pushing on the pump handle until desired pressure is shown on gauge. (See *Pump* Section)
4. Unthread pump from air valve; measure the sag.

Repeat step 1-4 until proper sag is achieved. Replace valve cap after sag is set.

FLOAT Sag Table					
Common Shock Lengths		Shock Travel		Recommended Sag	
(inches)	(millimeters)	(inches)	(millimeters)	(inches)	(millimeters)
5.500	139.7	1.00	25.4	.25	6.4
6.000	152.4	1.25	31.8	.31	7.9
6.500	165.1	1.50	38.1	.38	9.5
7.250	184.2	1.75	44.4	.44	11.1
7.875	200.0	2.00	50.8	.50	12.7

## FLOAT

### Shock Features

Adjustable Air Spring - Internal Floating Piston - Oil Damping - Self Adjusting Air Negative Spring  
Nitrogen Charged - Speed Sensitive Compression Damping

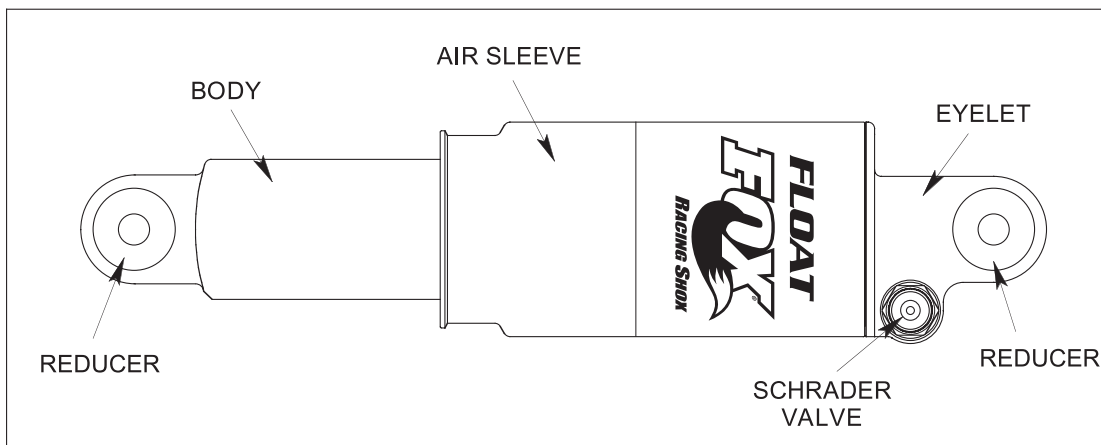

## FLOAT R

### Shock Features

Adjustable Air Spring - Internal Floating Piston - Oil Damping - Self Adjusting Air Negative Spring  
Nitrogen Charged - Speed Sensitive Compression Damping - Externally Adjustable Rebound Damping  
Speed Sensitive Rebound Valve Stack

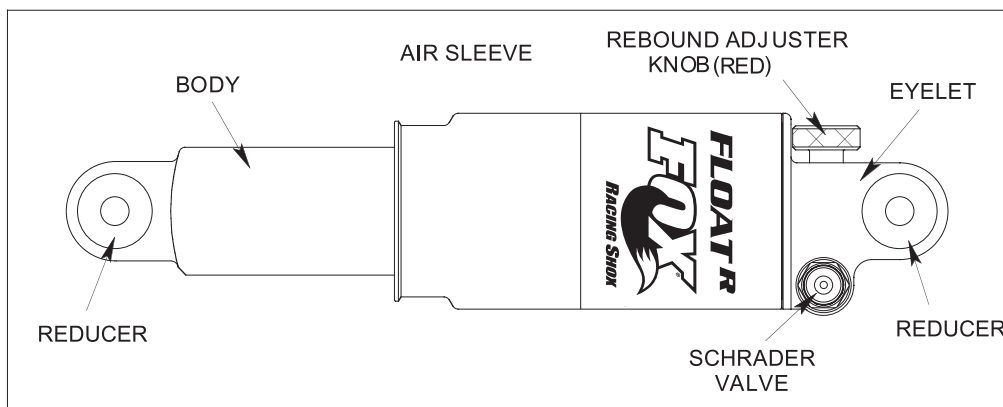

### Rebound Adjustment

Rebound damping controls the rate at which the shock returns after it has been compressed. The red adjuster dial can be turned clockwise for slower rebound and counter-clockwise for faster rebound. There is a wide range of adjustment enabling the rider to tune the shock to any air pressure and riding condition. The proper rebound setting is a personal preference and varies depending on rider weight, riding style and riding conditions. As a general rule, rebound should be as fast as possible without kicking back and pushing the rider off the saddle when riding the bicycle in rough terrain. If rebound is too slow the suspension will not function properly and the wheel will not follow the changing terrain. Determining the proper rebound setting may take a number of rides. Use the "curb test" to start dialing in your rebound setting. Do this test on flat ground where there is little auto traffic and plenty of room. Ride at normal cruising speed and stay seated. Ride off a curb and monitor the rebound. If the bike oscillates a few times after landing the rebound is too fast. If the shock does not return promptly it is too slow. Start with the dial in the middle (about 12 clicks from full slow) and adjust 4 clicks in the direction needed. Single clicks of adjustment can be used to fine tune the rebound damping. During the first few rides, adjust the rebound damping and note the different ride characteristics. Your rebound damping setting may change with different riding conditions.

## FLOAT L

### Shock Features

Adjustable Air Spring - Internal Floating Piston - Oil Damping - Self Adjusting Air Negative Spring  
Nitrogen Charged - Speed Sensitive Compression Damping - Factory Tuned Rebound Damping  
Compression Lock-out with High Speed Blow-off

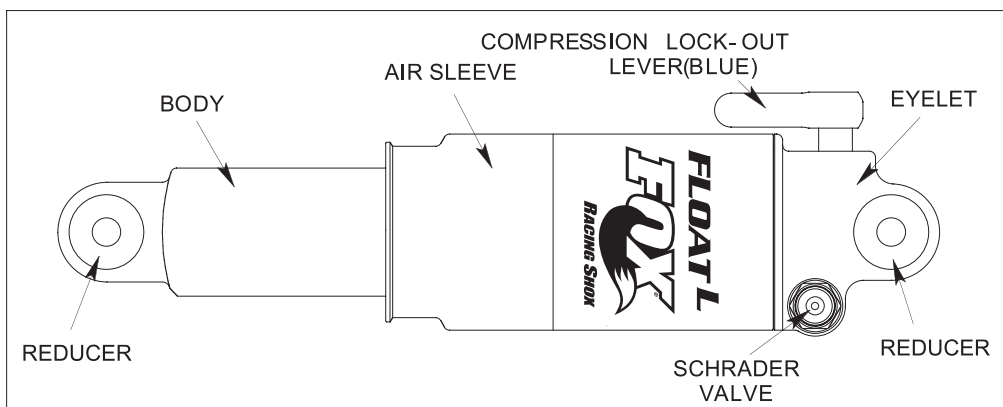

### Compression Lock-out

The compression lock-out is the blue lever. There are two options for lever position. For one option, the lever is at a 45° angle counter clockwise to the shock in the normal position. Moving the lever clockwise 90° increases compression damping which "locks-out" the shock. For the other option, the lever is in line with the shock in the normal position. Moving the lever 180° in either direction increases compression damping. The increased compression damping setting will be firm but will "blow-off" under a big hit or heavy load.

## FLOAT RL

### Shock Features

Adjustable Air Spring - Internal Floating Piston - Oil Damping - Self Adjusting Air Negative Spring  
 Nitrogen Charged - Speed Sensitive Compression Damping - Externally Adjustable Rebound Damping  
 Speed Sensitive Rebound Valve Stack - Compression Lock-out with High Speed Blow-off

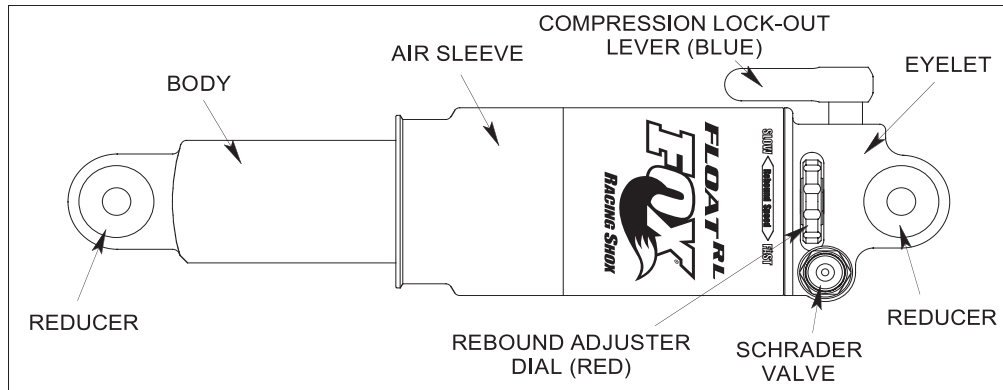

### Rebound Adjustment

Please refer to Rebound Adjustment for FLOAT R.

### Compression Lock-out

Please refer to Compression Lock-out instructions for Float L.

## Enduro FLOAT R & FLOAT RL

The Enduro FLOAT R and Enduro FLOAT RL shocks feature a switch that adjusts travel. When the switch is in line with the shock, it is in Long Travel mode and has 1.875 inches of travel. When the switch is turned 90° in either direction the shock changes to short travel mode and has 1.375 inches of travel. Spring Rate is also stiffer in short travel mode.

*Important* - All air pressure adjustments, adding or releasing air pressure, must be done in the long travel mode. Sag should be set in the long travel position. (See page 8 for instructions on Adjusting Sag) If pressure is released when the shock is in the short travel mode it must be switched to long travel mode and pressurized to at least 10 psi greater than the starting pressure. For example, if the shock has 150 psi and the pressure is released in short travel mode, the shock must be switched to long travel mode and then pressurized to at least 160 psi. Pressure can then be released as long as the shock remains in long travel mode.

The Enduro FLOAT R and Enduro FLOAT RL also feature a Rebound Adjuster Dial. Turning the dial clockwise slows the rebound. Counter-clockwise rotation speeds the rebound. Move the dial one click at a time until desired rebound is achieved.

Travel Adjustment  
Switch



Rebound Adjuster



Switch in Short -Travel Position    Switch in Long-Travel Position

### Air Volume Adjuster - AVA

Some FLOAT shocks feature an Air Volume Adjuster or AVA. AVA technology affords a new level of fine tuning adjustment for mountain bike rear shocks. Turning the AVA ring increases or decreases the volume of the positive air spring chamber allowing the rider to alter the shape of the spring curve. The AVA system creates a shock that, in its smallest setting, is up to 30% more linear spring rate than a standard FLOAT shock. AVA allows as much as 200 lbs of adjustment in spring rate from fully closed to fully open when fully compressed.

AVA is a pre-ride tuning feature. The AVA system is not intended to be used on the trail or on the fly.

It is important to clean your shock, especially the threads of the AVA air sleeve prior to adjustment.

In most cases, maximum air volume will be desired. Rotation of the AVA ring requires near complete deflation of the shock. Using a shock pump, let most or all of the air from the shock so that the AVA ring can be easily turned. Turn the ring until it just touches the wire ring which is snapped onto the air sleeve. This is the maximum volume setting. Pressurize the shock and set sag as normal. AVA does not affect sag. If the shock seems to bottom out too easily or too often, deflate the shock, rotate the ring to the next setting on the air sleeve. Pressurize the shock, set sag and test again for full stroke performance. Repeat this process until the setting that best fits your riding style and terrain is determined.

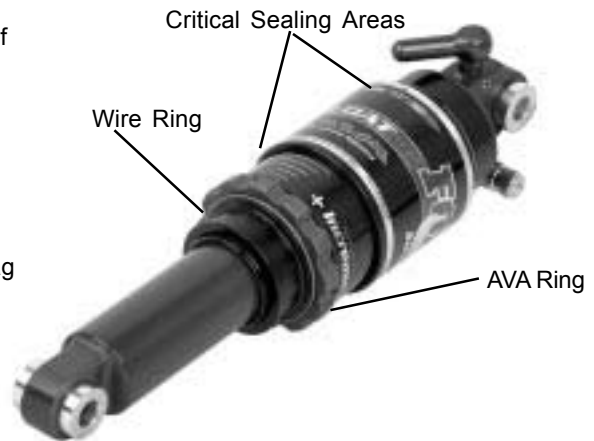

Air sleeve service can be performed as on other FLOAT shocks. Clean AVA seals after every other normal FLOAT seal service, especially if riding conditions are muddy or dusty. Carefully remove wire rings and air sleeves. Clean and inspect seals and parts for damage or wear. Re-lubricate and carefully re-assemble. Refer to diagram for areas with critical sealing and lubrication needs.

### Travel Adjust Linear Air Spring - TALAS

Some bicycles are equipped with FOX Racing Shox TALAS technology. TALAS stands for Travel Adjust Linear Air Spring. Travel can be adjusted changing the geometry of the bicycle to adapt to a wide variety of riding conditions and styles creating a versatile bicycle.

To optimize the performance of the shock, it is important to set it up correctly. Take the time to tune the spring rate (air pressure), rebound damping (rate at which the shock returns) and become familiar with the performance of the shock.

To set the air pressure on your TALAS equipped shock, see page 8 about setting sag. Sag should be set with the shock in the EXTEND position.

The TALAS shock has three (3) settings - EXTEND, -1/4 and -1/2. The -1/4 and -1/2 settings shorten the eye-to-eye length of the shock which will change the geometry of the bicycle. Rotate the lever to EXTEND for full extension. Rotate the lever one(1) click to the -1/4 position. The next time there is input into the shock, it will shorten 1/4". Rotate the lever one(1) more click to -1/2. The overall eye-to-eye length of the shock will be 1/2" shorter. To fully extend the shock, rotate the lever to EXTEND, stand up and unweight the back of the bicycle. This will allow the shock to return to full extension.

Contact FOX Racing Shox or an Authorized Service Center regarding service and repairs for TALAS equipped shocks.

TALAS Rear Shock Adjustments	
EXTEND to -1/4	Yes
-1/4 to -1/2	Yes
-1/2 to EXTEND	Yes
-1/2 to -1/4	No

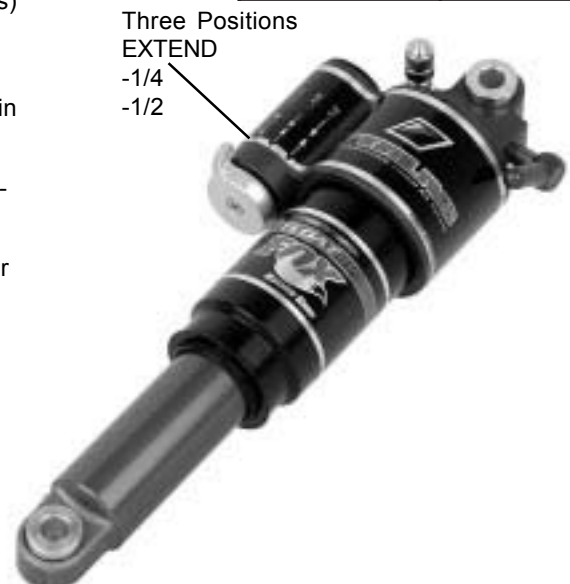

**Air Sleeve Maintenance** See [www.foxracingshox.com](http://www.foxracingshox.com) for downloadable video instructions.

Release all air pressure from Air Valve.

Cycle shock a few times to release pressure from the air negative spring.

Release all air pressure from Air Valve again.

Remove shock from bike

Remove aluminum reducers.

Clamp shaft eyelet in a vise with soft jaws being careful not to crush the air valve, lock out lever, or rebound knob.

Slide a screwdriver or punch through the body eyelet to keep the air sleeve from coming off the body.

Loosen air sleeve by turning counter clockwise and slide it down the body.

Remove screwdriver or punch.

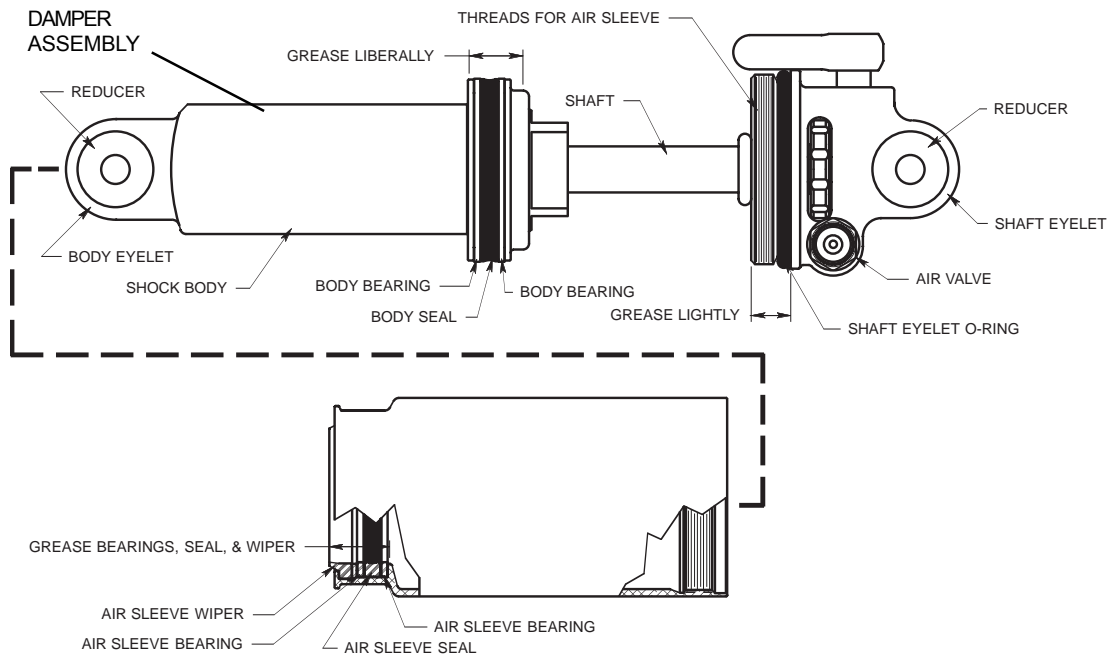

**Cleaning and Inspecting**

Clean inside of the air sleeve with parts cleaner.

Inspect the seal and bearing inside of the air sleeve.

Replace if damaged or worn.

Clean body, body seal, body bearings and shaft with parts cleaner.

Inspect body seal and body bearings for wear or damage.

Replace if damaged or worn.

**Greasing and Reassembling**

Lightly lube the shaft eyelet O-ring and shaft eyelet threads with FLOAT Fluid or Multi-purpose Lithium based grease (NLGI #2).

Liberaly lube the body seal and body bearing, leaving a reservoir of lube above the body bearing .

Lightly grease the air sleeve seal, air sleeve bearing, and air sleeve wiper.

Slide the air sleeve over the body until the air sleeve wiper is at the end of the body. Leave the air sleeve unthreaded at this time.

(The air sleeve will be very difficult to compress because there is pressure trapped in the air negative chamber.

Waiting until after the shock is mounted in the bike will allow the leverage of the bike to easily compress the shock.)

Dry bushings and reducers.

Install reducers in eyelet bushings.

Install shock in bike.

Carefully compress shock until you can screw on the air sleeve. Do not let the air sleeve slip off the body.

Thread air sleeve onto shaft eyelet.

Inflate shock using inflation instructions listed in the *Pump Instructions*.

*Note: If needed, the Air Sleeve Seal Kit part number is 803-00-050-B.*

*LOAT Fluid part numbers: 025-03-002-A 5 cc Pillow Pack*

*025-03-003-A 8 oz. Bottle*

**Specialized Epic BRAIN**

Your Specialized bicycle features a FOX Racing Shox FLOAT R with BRAIN Technology. This technology senses bumps in the trail and activates the suspension as necessary giving the rider the efficiency of a hardtail with all the benefits of a full suspension bicycle.

To optimize the performance of the shock, it is important to set it up correctly. Taking the time to tune the spring rate (air pressure) and rebound damping (rate at which the shock returns) will greatly enhance the riding experience.

Because the shock defaults to a locked out position, the shock cannot be set up using the traditional method for setting sag. For this reason we recommend that the initial set up be done according to the air spring chart below. Find your weight range on the chart below and set the air pressure to the corresponding value. Take a shock pump along on the next ride and monitor the performance of the shock. Slide the travel indicator o-ring up against the scraper lip before starting to ride. This will help show how much travel is being used. If the shock seems to bottom excessively, increase the air pressure by five (5) psi. If the shock seems too stiff or if full travel is not achievable, decrease the air pressure by five (5) psi. The goal is to use the full travel of the shock once or twice on each ride. Full shock travel is 1 7/8 inches +/- 1/8 in (48 millimeters +/- 3 mm). Much of this depends on the terrain and one's riding style so take these into consideration during the set up process.

Rebound damping controls the rate at which the shock returns after it has been compressed. The red adjuster dial can be turned clockwise for slower rebound and counter-clockwise for faster rebound. There is a wide range of adjustment enabling the rider to tune the shock to any air pressure and riding condition. The proper rebound setting is a personal preference and varies depending on rider weight, riding style and riding conditions. As a general rule, rebound should be as fast as possible without kicking back and pushing the rider off the saddle when riding the bicycle in rough terrain. If rebound is too slow the suspension will not function properly and the wheel will not follow the changing terrain. Determining the proper rebound setting may take a number of rides. Use the "curb test" to start dialing in your rebound setting. Do this test on flat ground where there is little auto traffic and plenty of room. Ride at normal cruising speed and stay seated. Ride off a curb and monitor the rebound. If the bike oscillates a few times after landing the rebound is too fast. If the shock does not return promptly it is too slow. Start with the dial in the middle (about 12 clicks from full slow) and adjust 4 clicks in the direction needed. Single clicks of adjustment can be used to fine tune the rebound damping. During the first few rides, adjust the rebound damping and note the different ride characteristics. Your rebound damping setting may change with different riding conditions.

Air sleeve service can be performed as on other FOX Racing Shox FLOAT rear shocks (see pages 10&11 for details). The strut must be removed before removing the air sleeve. A 22mm open end wrench is required to remove the strut. Torque to 175-200 in-lb (19.5-22.5 N-m) when reinstalling. A 22mm crowfoot attachment and a torque wrench are required to install the strut.

Note: Excepting air sleeve service, all repairs and warranty issues must be handled by Specialized Bicycle Company. All repairs and service for BRAIN technology shocks will be provided through an Authorized Specialized Dealer in your country. Please contact your local Specialized dealer for repair and warranty issues.

**BRAIN Air Spring Chart**

Rider Weight Lbs. (Kg.)	Air Pressure Psi
90 - 100 (34-37)	60 - 65
100-110 (37-41)	65 - 70
110-120 (41-45)	70 - 75
120-130 (45-49)	75 - 80
130-140 (49-52)	80 - 85
140-150 (52-56)	85 - 90
150-160 (56-60)	90 - 100
160-170 (60-63)	100 -110
170-180 (63-67)	110 - 120
180-190 (67-71)	120 - 130
190-200 (71-75)	130 - 140
200-210 (75-78)	140 - 150
210-220 (78-82)	150 - 160
220-230 (82-86)	160 - 170
230-240 (86-90)	170 - 180
240-250 (90-93)	180 - 190
250-265 (93-99)	190 - 200
265-280 (99-105)	200 - 215
280-295 (105-110)	215 - 230



## Remote Lock-Out Instructions

Clean eyelet and air sleeve with degreaser.

Set shock lock-out to locked-out position. Fig. 2

Remove lever with a 5/64 (or 2mm) hex key.  
DO NOT REMOVE CAM. DO NOT LOOSEN  
SET SCREWS.

Place adapter plate on the eyelet and over  
the cam (M.Y. 2000 & 2001 only). Fig. 1

Insert torsion spring in corresponding hole on plate or eyelet. Fig. 1

Position new remote lever over cam onto torsion spring arm. Fig. 1

Rotate remote lever counter-clockwise to preload the spring and align the flat. Tighten set screw onto the flat of the cam. Fig. 3

Attach cable stop collar onto air sleeve flange. Orient cable stop just off center. (Fig. 3) Overtightening the collar can crush the air sleeve. Tighten collar only until it is secure and does not rotate on air sleeve.

Let air out of shock and cycle to full bottom out. Check clearances of all parts in compressed and extended positions.

Cut cable and housing to length. Use only derailleur cable and housing. (1.1mm stainless cable is recommended)

Run cable around radius on remote lever and through the hole. Push cable through housing and route along frame to cable stop collar and around remote lockout lever. Apply tension on cable and tighten set screw to hold the cable - DO NOT OVERTIGHTEN. Fig. 3

Adjust cable tension with the barrel  
adjuster at handlebar mounted lever.

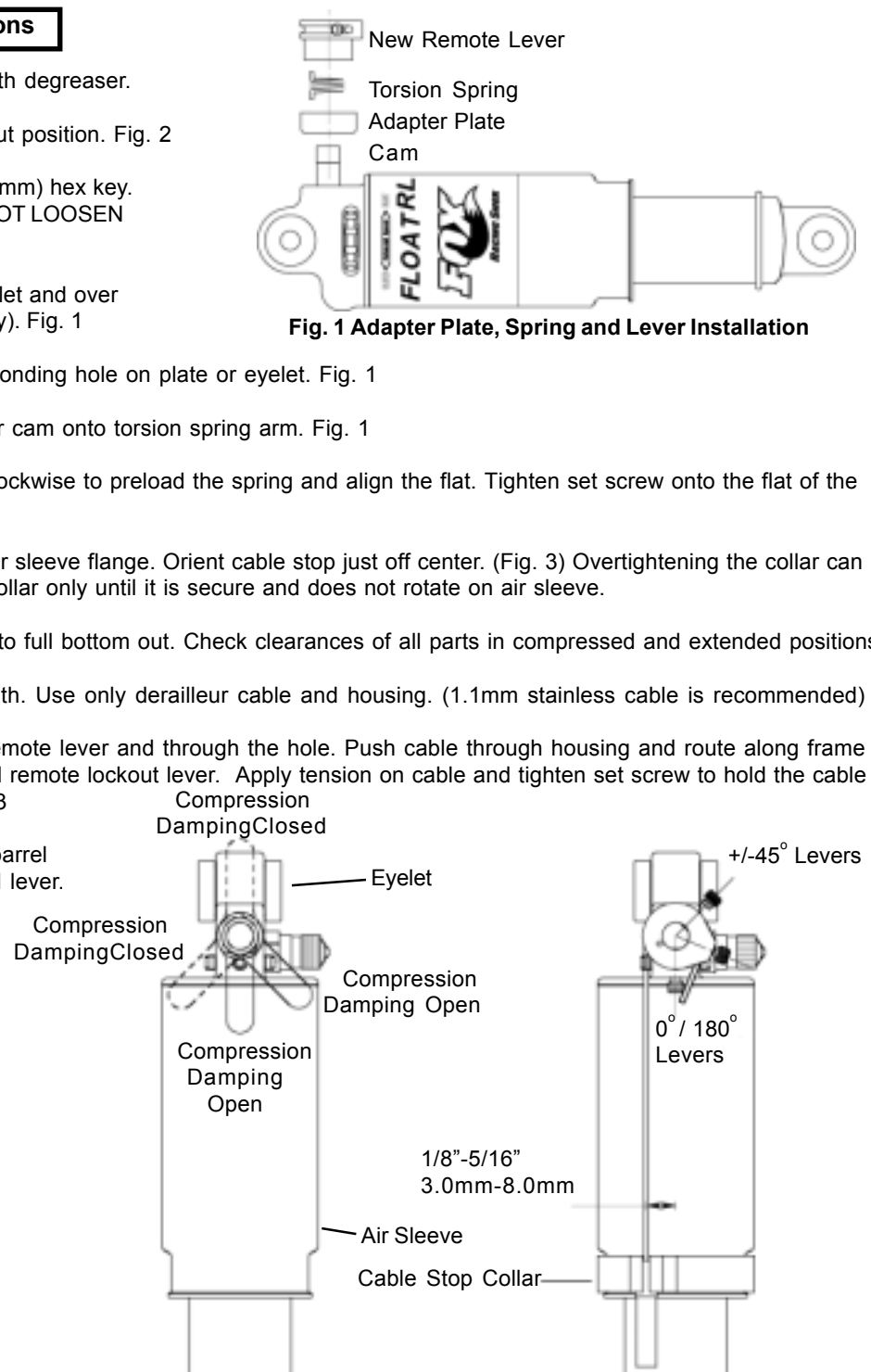

## Remote Lock-Out Lever Installation Instructions

The remote lock-out lever can be installed above or below the handlebar on either the left or right side. The lever comes pre-assembled to be mounted on top of the handlebar on the right side.

To re-orient the lever, remove the lever assembly from the clamp assembly with a 2mm (or 5/64) hex wrench.

Mount clamp assembly in desired location and re-mount lever assembly.  
DO NOT OVERTIGHTEN mounting screws.

To adjust lever friction, use a 3mm hex wrench to tighten or loosen the button head screw in the middle of the lever housing. Use an 8mm (or 5/16) socket to hold the nut on the bottom of the lever housing.

## Vanilla Shocks

To get the best performance from your Vanilla shock, it is necessary to adjust sag. On the coil-over shocks this is done by adjusting the spring preload or changing springs. Sag is how much the shock compresses when you sit on the bicycle. Increasing spring preload will make the shock compress less. Decreasing the preload will make the shock compress more. The smoothest ride will be achieved with one turn of preload. (Note: it might be necessary to change spring rate to achieve the proper sag setting.) Adjusting sag setting is easiest with two people, the bike rider and an assistant.

### Adjusting Sag

Vanilla Sag Table			
Shock Travel		Recommended Sag	
(inches)	(millimeters)	(inches)	(millimeters)
1.00	25.4	.25	6.4
1.25	31.7	.31	7.9
1.50	38.1	.38	9.5
1.75	44.4	.44	11.1
2.00	50.8	.50	12.7
2.25	57.1	.56	14.3
2.50	63.5	.63	15.9
2.75	69.9	.69	17.5

**If more than 2 turns of preload are required to achieve the correct amount of sag, it is recommended that a higher rate spring be installed.**

To set the preload, you need to adjust the spring preload ring. FOX Racing Shox recommends no more than 2 turns of preload. Adjust preload by turning the preload ring onto the body. Clockwise turns increase preload, which decreases the sag. Counterclockwise turns decrease preload, which increases sag.

If desired preload cannot be achieved with the preload ring, change the spring (See *Installing and Removing Springs*). A stiffer spring (higher spring rate) decreases sag. A softer spring (lower spring rate) increases sag.

**Springs are available from FOX Racing Shox as well as authorized dealers and service centers.** Numbers are printed on the outside of the spring coils indicating the rate (in pounds) and travel (in inches). Example: 550-1.95 is a 550 pound-per-inch spring rate with 1.95 inches of travel. Please note this number when ordering replacement springs. Also be prepared with the make, model, and year of bicycle, shock travel, rider weight and riding style.

### Installing and Removing Springs

To remove the spring from your shock, follow these steps:

#### Vanilla, Vanilla R & Vanilla RL

Loosen and remove the preload ring from the body.  
 Note: It might be necessary to remove the reducers from the body end of the shock to remove the spring.  
 Slide the spring over the shock body.  
 Install your new spring by sliding the spring over the shock body.  
 Tighten the preload adjuster one full turn to keep the preload ring from shaking loose.

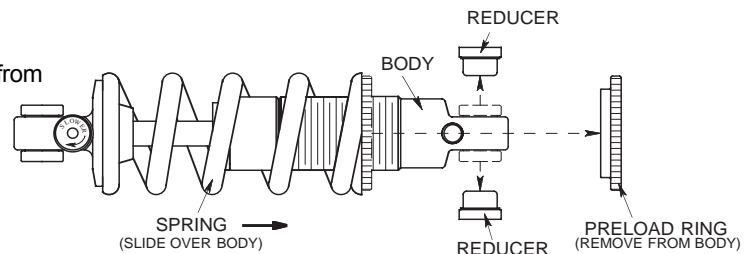

#### Vanilla RC

Back off preload ring to loosen the spring until the slotted spring retainer can be removed from the shock.  
 Note: It might be necessary to remove the reducers from the shaft end of the shock to remove the spring.  
 Slide the spring over the eyelet.  
 Slide the new spring on over the eyelet, and re-install the spring retainer.  
 Note: The slotted spring ring retainer slot must rest on the flat side of the spring. If the slot is straddling the gap caused by the end of the spring wire the slotted spring retainer may bend.  
 Tighten the preload adjuster one full turn to keep the spring retainer from shaking loose.  
 Align the slotted spring retainer so that the rebound knob is in the middle of the slot.

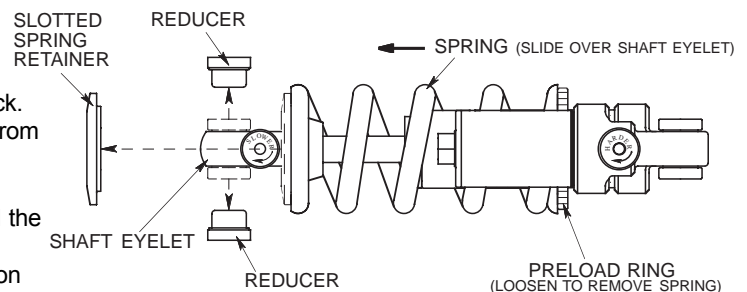

## Vanilla

### Shock Features

Adjustable Spring Preload - External Coil Spring - Internal Floating Piston - Oil Damping  
One Piece Aluminum Body - One Piece Eyelet - Nitrogen Charged - Speed Sensitive Compression Damping

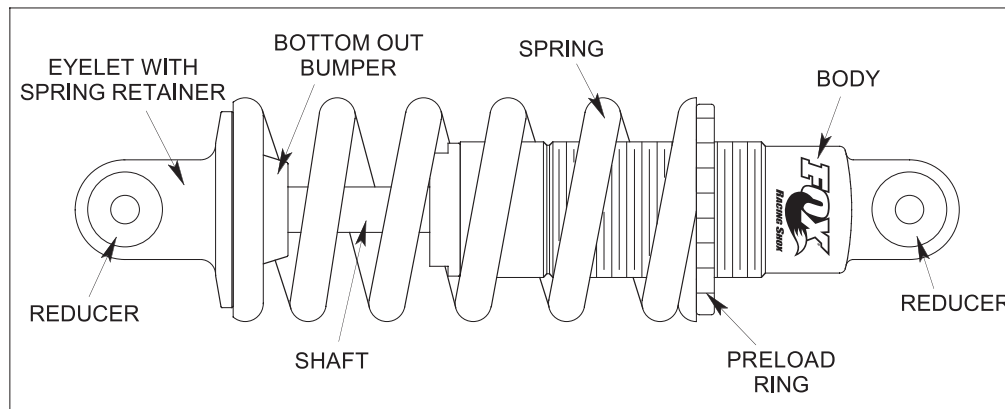

## Vanilla R

### Shock Features

Adjustable Spring Preload - External Coil Spring - Internal Floating Piston - Oil Damping  
One Piece Aluminum Body - One Piece Eyelet - Nitrogen Charged - Speed Sensitive Compression Damping  
Multi-Valve Piston - 12 Click Externally Adjustable Rebound Damping - Speed Sensitive Rebound Valve Stack

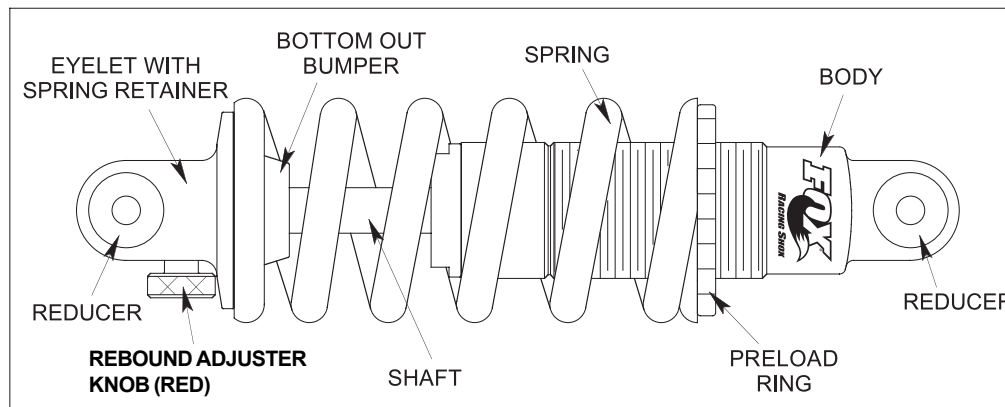

### Rebound Adjustment

Rebound damping controls the rate at which the shock returns after it has been compressed. The red adjuster dial can be turned clockwise for slower rebound and counter-clockwise for faster rebound. There is a wide range of adjustment enabling the rider to tune the shock to any air pressure and riding condition. The proper rebound setting is a personal preference and varies depending on rider weight, riding style and riding conditions. As a general rule, rebound should be as fast as possible without kicking back and pushing the rider off the saddle when riding the bicycle in rough terrain. If rebound is too slow the suspension will not function properly and the wheel will not follow the changing terrain. Determining the proper rebound setting may take a number of rides. Use the "curb test" to start dialing in your rebound setting. Do this test on flat ground where there is little auto traffic and plenty of room. Ride at normal cruising speed and stay seated. Ride off a curb and monitor the rebound. If the bike oscillates a few times after landing the rebound is too fast. If the shock does not return promptly it is too slow. Start with the dial in the middle (about 12 clicks from full slow) and adjust 4 clicks in the direction needed. Single clicks of adjustment can be used to fine tune the rebound damping. During the first few rides, adjust the rebound damping and note the different ride characteristics. Your rebound damping setting may change with different riding conditions.

## Vanilla RL

### Shock Features

Adjustable Spring Preload - External Coil Spring - Internal Floating Piston - Oil Damping  
One Piece Aluminum Body - One Piece Eyelet - Nitrogen Charged - Speed Sensitive Compression Damping  
Multi-Valve Piston - 12 Click Externally Adjustable Rebound Damping - Speed Sensitive Rebound Valve Stack  
Compression Lock-out with High Speed Blow-off

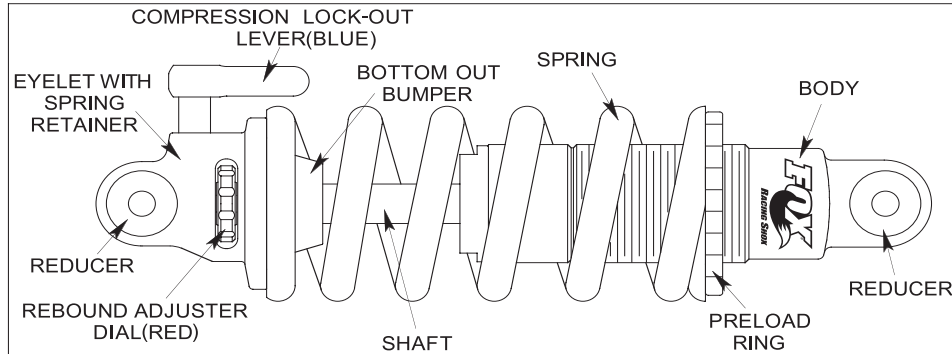

### Rebound Adjustment

Please refer to Rebound Adjustment for Vanilla R.

### Compression Lock-out

Compression lock-out is featured on the Vanilla RL Shock. The compression lock-out is the blue lever. There are three options for lever position for the Vanilla RL. For one option, the lever is at a 45° angle counter clockwise to the shock in the normal position. Moving the lever clockwise 90° increases compression damping which “locks-out” the shock. On another option, the lever is in line with the shock in the normal position. Moving the lever 180° in either direction increases compression damping. On the third option, the lever is in line with the shock in the normal position. Move the lever 90° clockwise to increase compression damping. The increased compression damping setting will be firm but will “blow off” under a big hit or heavy load.

## Vanilla RC

### Shock Features

Adjustable Spring Preload - External Coil Spring - Internal Floating Piston - Oil Damping  
One Piece Aluminum Body - One Piece Eyelet - Nitrogen Charged - Speed Sensitive Compression Damping  
Multi-Valve Piston - 12 Click Externally Adjustable Rebound Damping - Speed Sensitive Rebound Valve Stack  
Piggy Back Remote Reservoir - 12 Click Externally Adjustable Compression Damping

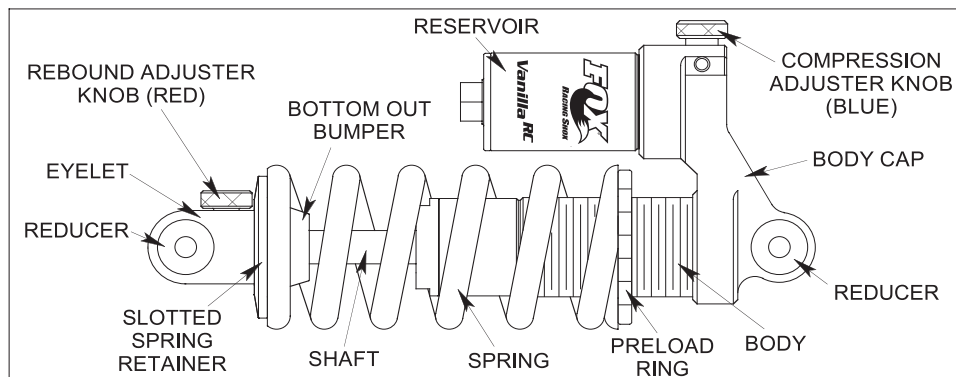

### Rebound Adjustment

Please refer to Rebound Adjustment for Vanilla R.

### Compression Damping

Compression damping on the Vanilla RC is adjusted by turning the blue knob. To make the shock harder to compress, turn the knob clockwise. Turn the knob counter-clockwise for easier compression. Adjust the compression on the first few rides and note the different characteristics. Your settings may change with different conditions. The smoothest ride will be attained with the compression adjuster in the softest setting.

## M-BITS by FOX Racing Shox

Your bicycle features M-BITS by FOX Racing Shox as part of the rear suspension system.

To optimize the performance of the shock, it is important to set it up correctly. Taking the time to tune the spring rate (air pressure) and rebound damping (rate at which the shock returns) will greatly enhance the riding experience.

Air pressure is increased or decreased by attaching a shock pump to the schrader valve on the left side (from rider's perspective) of the shock body. Please reference the chart below to set the air pressure. These air pressures are provided as a guide and should be used as a starting point. Make incremental adjustments to air pressure on the first few rides and monitor how the ride characteristics change. This will help determine your optimal air pressure.

With the air pressure properly set, the shock should compress about 17-20mm when the rider sits on the bicycle in a normal riding position. This is called sag. If the shock sags too much, increase the air pressure slightly. If the shock doesn't sag enough, slightly decrease the air pressure.

The air pressure range for the shock is 5 to 60psi for most riders. If significantly more pressure is required to achieve proper sag, please contact your bicycle manufacturer or FOX Racing Shox.

Rider Weight Lbs. (Kg.)	Air Pressure PSI
<100 (45)	25
120 (55)	30
140 (65)	35
160 (75)	40
180 (85)	45
200+ (90+)	50-60

Alternate Methods: Divide rider's weight in pounds by 4 to determine PSI or rider's weight in kilograms by 27 to determine bar.

Example: 160lb. rider -  $160/4 = 40$  psi  
81kg rider -  $81/27 = 3.0$  bar

Use the knob on the left side (from rider's perspective) of the shock to adjust the rebound damping. Refer to the chart below to find the setting recommended relative to your air pressure.

The proper rebound setting is a personal preference and varies depending on rider weight, riding style and riding conditions. As a general rule, rebound should be as fast as possible without kicking back and pushing the rider off the saddle when riding the bicycle in rough terrain. If rebound is too slow the suspension will not function properly and the wheel will not follow the changing terrain. Determining the proper rebound setting may take a number of rides. Use the "curb test" to start dialing in your rebound setting. Do this test on flat ground where there is little auto traffic and plenty of room. Ride at normal cruising speed and stay seated. Ride off a curb and monitor the rebound. If the bike oscillates a few times after landing the rebound is too fast. If the shock does not return promptly it is too slow. During the first few rides, adjust the rebound damping and note the different ride characteristics. Your rebound damping setting may change with different riding conditions.

PSI	Bar	Adjuster Number
<10	<1.0	1
10-20	1.0-1.5	2
20-30	1.5-2.0	3
30-40	2.0-2.5	4
40-50	2.5-3.0	5
50+	3.0+	6

