

WORKSHOP 2004

www.magura.com

Deutsch
English
Français
Nederlands
Italiano
Español



JULIE®

Table of Contents

1. Introduction	3
2. Safety instructions before the first ride	4
3. Safety instructions before every ride	4-5
4. Transport of the bicycle	5
5. Brake installation	6-9
6. Shortening the hose	10-11
7. Maintenance	12-13
8. Repairs	14-15
9. Bleeding and Filling	15-17
10. Trouble Shooting	17
11. The disc brake wheel	18
12. Accessories	19-20
13. Warranty	20
14. Spare parts exploded view	21



WARNING:

This symbol means possible danger for your health and even life if you do not follow the instructions given respectively if the necessary safety measures are not followed.



ATTENTION:

This symbol warns you of inappropriate handling that might cause serious damage to the material and/or the environment.



NOTE:

This symbol gives you additional information about the general handling of the product or gives hints to paragraphs in this manual which have to be read carefully.

1. Welcome to the Brake People!



Brake lever (master cylinder)
MAGURA Julie

Congratulations! You have purchased a fully hydraulic MAGURA disc brake proudly „Made in Germany“. You will be amazed at the awesome braking power and the minimum amount of maintenance that is necessary on our stoppers. Good to know that you are not alone, millions of riders worldwide rely on them and every day our numbers are increasing.

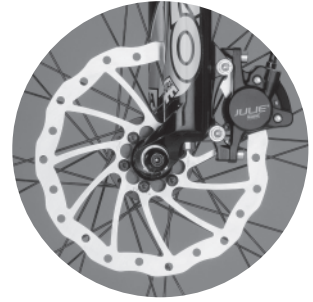

Brake caliper and rotor
MAGURA Julie

On the fully hydraulic MAGURA disc brake system Julie the braking force is transmitted to the braking surface by a mineral oil column. The movement of the lever blade moves a piston, which is integrated in the brake lever (master cylinder). The piston pushes the mineral oil column through the brake hose in the direction of the brake caliper, where two pistons, on which the brake pads are fixed, are pushed out. The friction between the brake pads and the rotor slows down the bicycle and causes both the rotor and the brake calliper to heat up.

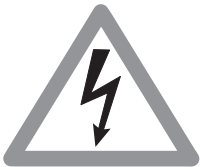

Never touch either the rotor or the brake caliper after long braking as this may cause serious burns.

You will be pleased to find out that the MAGURA Julie disc brakes offer a superior braking power even with little hand force applied, no matter what the weather conditions should be. Particularly in wet weather conditions disc brakes are much more responsive than rim brakes and transmit their enormous power immediately after activating the brake lever.

Disc brakes don't wear your rims down. However, if they have been mounted incorrectly, they might cause a squealing noise during braking, mainly during wet weather conditions.

This manual contains important information about the safe installation, operation and maintenance of your MAGURA disc brake. We urge you to read it carefully, become familiar with its contents and follow our recommendations to help make your new braking experience enjoyable and trouble free.

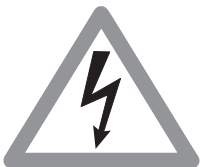

Although the Julie disc brake system is relatively simple you should not overestimate your technical skills! We therefore advise you to leave the following operations to a trained technician of a professional bike shop.

Should there be any further questions or problems we warmly recommend that you visit our website www.magura.com where you will always find the newest and hottest tips about all our products. Stay tuned with the Brake People!

Thank you for your confidence in our products, enjoy your ride and your new MAGURA disc stoppers!

Happy trails!

2. Before the first ride

1. Are you already familiar with hydraulic disc brakes? Our brakes might be much more powerful than the stoppers on which you relied on so far. Take your bicycle to a safe area to learn the proper braking technique and operation of your new brakes and your bike.

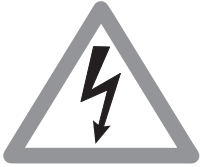

2. Check that the front brake is still actuated by the lever on the side you are used to braking with. Should this not be the case you will have to train to your new setup, otherwise any unintended front wheel braking manoeuvre may cause an accident leading to possible serious injury! If in doubt get a trained technician to swap the hoses. For further hints concerning swapping of the brake hose see page 10 onwards.

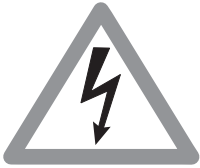

3. New brakes and new rotors or brake pads must always be run in by braking at least 30 times from a speed of 30km/h to achieve the maximum brake power. Take your bike to a safe place to run in the brake.

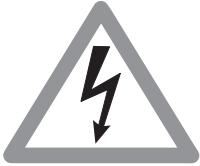

4. While riding in extreme riding conditions (total weight of bike plus rider over 100kg and/or a gradient of more than 15%) always use both brakes simultaneously to slow your bike down.

5. Do not use the Julie disc brake for downhill sport or on tandems! Any misuse might cause serious accidents with fatal injuries to yourself and others!

6. Are you familiar with the other components on your bike such as gears, clipless pedals and suspension units? Always practise using your bike in a safe area to improve your handling abilities before using it on the road. Consult the user's manual of your bike to learn more about this.

7. For your own safety always wear a helmet when you ride a bicycle. Make sure as well that you wear suitable clothing and footwear.

3. Before every ride

Always check carefully the following points:

1. Always make sure that the quick release skewers of your wheels and seat post are correctly mounted and closed.

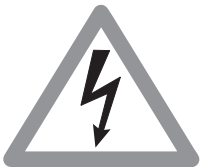

incorrectly installed quick release skewers might cause the fixed items to become loose. Serious accidents with severe injury may result!!

2. Always make sure that the brake lever pressure is o.k. by pulling the lever blade and ensuring that full braking performance is achieved before the lever blade touches the handlebars. If this is not the case, pull the lever blade several times (pump) until the brake pads touch the rotor.

Changing pressure points during a ride might be the result of having air in the brake system.

See hints about filling and bleeding from on pages 15/16.

3. Always make sure that the brake system does not have any leaks by activating the lever blade, holding it and checking the hose connections and reservoir cover for eventual leaks. (Also see page 11)

4. Always protect your rotors and brake pads from oil and lubricants (e.g. by lubricating your chain). Avoid detergents and soap on the brake pads. Contaminating the pads with oil and lubricants will cause a permanent loss of braking power. Such contaminated pads can no longer be used and should be replaced! Clean a contaminated rotor with dishwasher or alcohol. See further hints about changing the brake pads on pages 11-13.

5. Release your brake lever and check whether your wheel moves freely and without drag. Check eventually whether the wheels are correctly mounted and if the quick release skewers are tightened sufficiently. (Also see page 9)

6. Are your tires in a good condition, and have they enough air pressure? Test this with your fingers. Lift up your bike and turn the wheels of your bike. An insufficient rotation might be due to damaged tires, broken axles and/or broken spokes.

7. Pick up your bike and let it drop from a moderate height. Listen for any rattling noises. If any are heard check the bearings and all screwed connections.

8. Always follow the instructions given in the owner's manual of your bicycle.

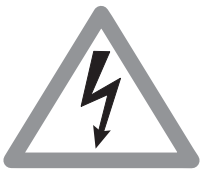

Never use your bicycle if any of the points mentioned above relate to your bicycle! Consult a professional bike mechanic if you feel unsure. A faulty bicycle may result in serious accidents with possible fatal injuries of the rider! Be careful to check always to check the following points:

4. Transport of the bicycle

In case of a disc brake equipped bicycle you should always keep in mind the following points:

Never activate the lever blade without the brake pads in place and the wheels mounted. In case this should have happened see page 10 of this manual.

Never throw away the transport device, which has been delivered with the brake. Always clip it between the brake pads whenever the wheel is removed (e.g. transport of the bike).

Always carefully removed wheels. Make sure that the rotors are not damaged, deformed or contaminated with lubricants.

If the bike is transported upside-down squeeze (with mounted wheel or transport device!) the lever blade before, hold pressure and fix the blade in this position with a rubber band or a cable tie.

During transport in an aircraft you can leave your brake as it is, e.g. you do not have to empty it.

5. Brake Installation

1. Tools for installation (+maintenance)

Allen key 2*, (3) and 5
transport/mounting device*
sharp knife
8mm open end wrench
flat blade screw driver
Torx T25 key*
(Torx T7 key)

(*delivered with the brake)

Always insert the allen and torx keys completely to avoid damaging the bolt heads.

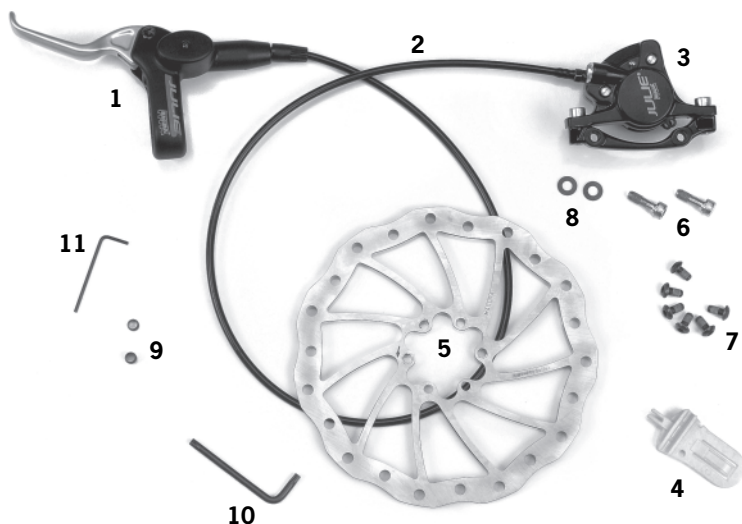

Unpack your Julie disc brake:

1. brake lever (master cylinder) connected through the
 2. brake hose with the
 3. brake caliper with transport device (IS/Postmount with quickmount adaptor)
ATTENTION: remove
 4. **YELLOW** transport device only shortly before installation of the wheel!!
 5. rotor (diameter front 180mm, rear 160mm)
 6. fitting bolts for caliper Allen key 5 (2 pieces)
 7. fitting bolts for rotor Torx key T25 (6 pieces)
 8. black 1mm spacers (2 pieces, **only necessary for rear brakes**)
 9. olives (2 pieces)
 10. Torx T25 key
 11. Allen key 2mm
- not shown:** hose fitting kit for rear brake (comes with all rear brakes)

specifications modifying and improving this product are subject to change without prior notice.

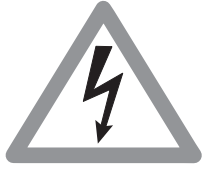

The brake levers, calipers and hoses of the different MAGURA disc brake models are completely different and not compatible! Never mix and match parts from the two models. Any misuse might cause serious accidents!

MAGURA manufacture these braking systems according to the valid standards and make many rigorous product tests. Because of the large variety of forks and frames available on the market it is impossible for MAGURA to test all possible combinations. If you mount any of our brake systems always make sure that the brakes are in conformity with the bicycle.



Disc brake calipers can generate a lot of heat during extreme riding conditions. The resulting heat transfer from the caliper to the fork and/or frame can have a negative influence on the mechanical characteristics of both the fork and/or the frame.

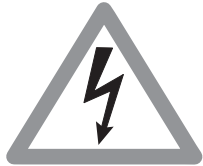

Insufficient heat transfer from the brake caliper to the frame and the fork, caused by fork and or frame components having low heat transfer characteristics (e.g. carbon rear triangles) can cause the brake to overheat, with the possibility of a total failure of the brake system. This can cause serious personal injury to yourself and/or others.

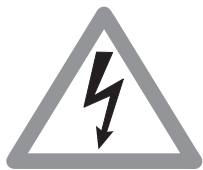

With respect to product liability we remind all our users that any manufacturer (also: bike mechanic or end consumer!) is responsible for the correct function of the complete bicycle in this context. Improper combinations and insufficient installation can cause damage and serious accidents!

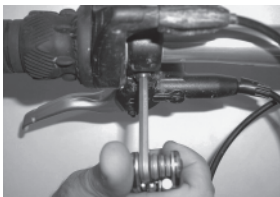

2. Mount the brake lever to the handlebar with a 5mm allen key. If you install your brake lever the first time you'll hear a crack, do not worry because of that. Tightening torque 4Nm/34 in.lbs



The MAGURA Julie disc brake is compatible with frames and forks which meet the international standard (IS) for disc brake installation. By dismantling the Quickmount adaptor, the front brake is also compatible with Manitou forks with Postmount mounts. Never mount the brakes with adapters or brackets from other manufacturers! All warranty will be void in case of any misuse! Use only direct mounting parts from MAGURA or the frame or fork's manufacturer!

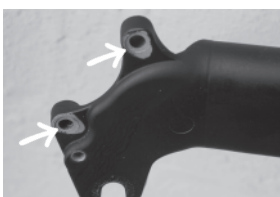

Make sure that the caliper fitting eyelets on your frame or fork are free of any paint, powder coating or burrs. (arrows). If this is not the case you should contact your dealer who will be able to clean the surfaces, providing an absolutely flat/even mounting surface (also see page 9).

ATTENTION: The treatment of suspension lower legs made of magnesium might be dangerous because of corrosion! Always follow the safety instructions given by the respective manufacturer! Always make sure after having treated the disc brake mounts that these are protected against corrosion by using an appropriate protective paint.

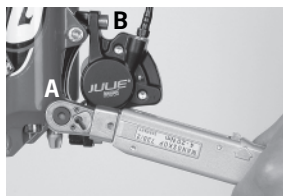

3. Mounting on forks and frames that meet the International Standard:
Mount the caliper onto the fork or the frame (bolts "A"). Use a 5mm allen key.
Tightening torque: 6Nm/51 in.lbs. Do not tighten yet the bolts "B"



4. Mount the rotor with the 6 Torx T25 bolts onto the hub. Watch out for the correct rotation direction of the rotor (laser arrow). Use only new original bolts or thread lock if you use old bolts. **Tighten the bolts in a crossed pattern! Tightening torque: 4Nm/34 in.lbs.**



5. Remove the transport device shortly before installing the wheel and mount the wheel.



6. Squeeze now the brake lever, hold the pressure and tighten the fitting bolts "B".
Tightening torque: 6Nm/51 in.lbs.

If you have a Manitou fork proceed exactly in the same way, but dismount the quickmount adaptor beforehand.

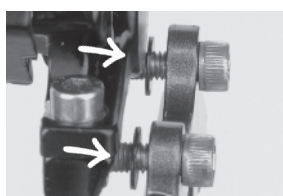

7. However you **must** use the black 1mm spacers between fitting eyelets and calliper on a **Julie rear brake**. If necessary you might have to use here as well additional 0,2mm spacers for a clean and drag free positioning of the calliper because frames are very often not well enough aligned.



The transport device prevents the brake pads from being pushed out too far by unintended lever squeeze. It is impossible then to install the wheel with the rotor. So never throw away the transport device. Keep it and always clip it between the brake pads when the wheel is removed.

Install the wheel by positioning the rotor between the brake pads and fixing the wheel in the dropouts. Close the quick release of your wheel **which you should mount on the opposite side of the brake caliper** and tighten it sufficiently. As to thru-axle hubs or wheels consult the manual of the respective fork manufacturer.

Squeeze the lever blade several times (pump) to push the pads to their proper position until the lever feel becomes very firm.



8. Correctly mounted disc brake wheel.

The rotor has to run directly under the separation line of the caliper halves (see arrow). If ever this is not the case re-position the calliper with the 0,2mm spacers.

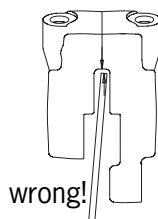
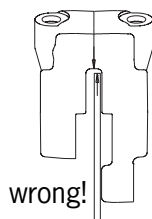
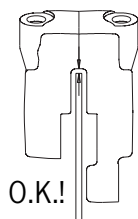

In the case of a **constantly dragging** disc brake causing noise your frame could be miss-aligned. In such a case you should contact your dealer who can care to this with the MAGURA Gnann-o-mat disc optimizer for a totally even surface of the disc brake mounts. These are absolutely necessary for a drag free function of your brake.



Do not worry when you hear friction between rotor and pads. A slight drag is normal on disc brakes with automatic pad wear adjustment during the break-in period. This drag will disappear after a while. The reason for this is that the brake pads find their optimum working position towards the rotor, only after a slight wear during the break-in period. Slight drag might also happen after a brake pad change or in case of an incorrectly installed wheel.

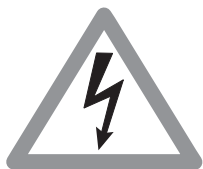

New brakes and/or new rotors or brake pads must always be run in by breaking at least 30 times from a speed of 30km/h to achieve the maximum brake power. Take your bike to a safe place to run in the brake.



Reach adjust is done with a 2mm Allen key. Turning key clockwise: lever blade moves away from the handlebar, turning counterclockwise: blade moves to the handlebar.

6. Shorten the hose

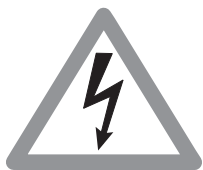

The Julie is a low-pressure system and comes with the same nylon hose that is used on MAGURA rim brakes. Do NOT use the reinforced hose of the other disc brakes with “Disc Tube” imprint and do NOT mix and match items of different MAGURA disc brakes! Any misuse might cause serious accidents!

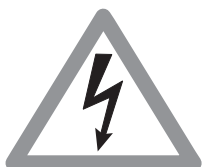

Never touch either the rotor or the brake calliper after long braking as this may cause serious burns.

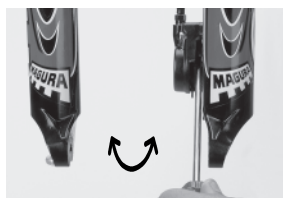

1. Remove the wheel so that you have free access to the brake calliper. Push back both brake pads by putting the transport device or a flat blade screwdriver into the gap. Move the screwdriver **slowly** back and forth until both calliper pistons are fully retracted and flush with calliper body.



Never push back the pistons without the brake pads mounted! Open the brake system only after having fully pushed back the brake pads.

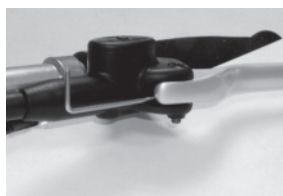

2. Loosen the brake lever clamping screw with a 5mm allen key. Turn the brake lever and ensure that the reservoir is horizontal. Squeeze slightly the lever blade and slide the 2mm allen key between brake lever and lever blade.



3. Slide the hose protection. Unscrew the sleeve nut on the brake lever with an 8mm open-end wrench and pull the hose out **carefully**. **Hold the hose carefully to avoid any loss of oil! Do not squeeze the lever blade with the system open!**



4. Put the hose on a workbench and shorten it with a sharp knife. The best tool is the MAGURA cutter (code 0321 233). **Do not use saws or pliers!**

If your frame is not equipped for routing hydraulic lines you should now mount the hose fitting kit (available as separate accessory, see magura.com) for your rear brake according to the instructions that are included in the kit.



Hold the hose carefully so that it cannot snap away! Cut the hose squarely! The sleeve nut can be re-used. The olive cannot be re-used and must be replaced!

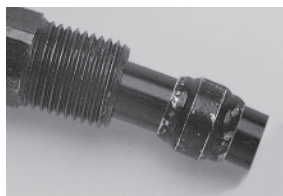

5. Slide on the sleeve nut and a **new** olive onto the hose. Push the hose with the sleeve nut and the new olive **fully** into the brake lever and tighten the sleeve nut with an 8mm open-end wrench. **Tightening torque: 4Nm/34 in.lbs.**

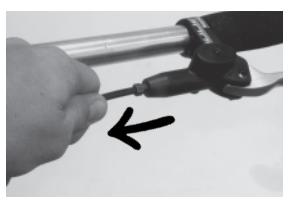

6. Always check for correct installation by pulling on the hose. Make sure that the system has no leaks. Squeeze the lever blade, hold pressure and check hose connections and the reservoir cover for eventual leaks.

Squeeze the lever blade several times (pump) to push the pads to their proper position until the lever feel becomes very firm. If you cannot realize this, bleed the brake (see page 15 onwards).

7. Maintenance

Brake Oil: MAGURA disc brakes use a transmission medium low viscosity mineral oil, the biodegradable MAGURA ROYAL BLOOD. Contrary to DOT brake fluid the MAGURA ROYAL BLOOD does not irritate human skin or strip the paint of your frame. Moreover it does not absorb water like DOT and does not have to be changed regularly. What sounds unbelievable is a fact: you can use your brakes over years without having to touch them (except brake pad change!)

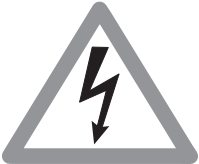

Always make sure that the brake system does not have any leaks by activating the lever blade, holding it and checking the hose connections and reservoir cover for eventual leaks. Consult a trained technician in case of leaks. Leaks cause poor braking performance with possible serious accidents!

As to hints about repairs of the hose see page 14 onwards..

Brake pads: wear, control and replacement

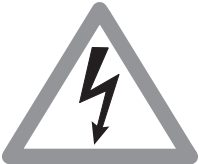

Brake pad wear: The brake pads are subject to wear due to friction between rotor and pads. The Julie disc brake features a fully automatic pad wear adjustment. Regularly check the thickness of your brake pads and replace them, if necessary!

Control and replacement of the brake pads

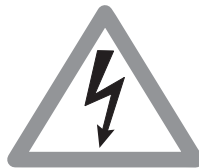

Never touch either the rotor or the brake calliper after long braking as this may cause serious burns.



1. Remove the wheel so that you have free access to the brake calliper. Push both brake pads back by putting the transport device or a flat blade screwdriver into the gap. Move the screwdriver **slowly** back and forth until both calliper pistons are fully retracted and flush with calliper body.



Never push back the pistons without the brake pads mounted!



2. Remove the cotter pin that holds the brake pads.



3. Pull out the brake pads. Their „ears“ make this very easy. Clean the pads with a dry rag that is free of oil and grease.



Never squeeze the lever blade without the brake pads in place and the wheel mounted. If this happened by accident push back the pistons with mounted brake pads by using the transport device or a flat blade screwdriver.



4. Minimum thickness of a brake pad including the holder is 2,5mm. Use only genuine MAGURA brake pads!!



Tip: check the pad wear with the groove of the YELLOW transport device. Pad does NOT fit to the groove (picture): o.k.! Pad does fit to the groove: change the pads!

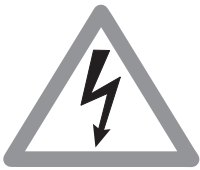

Use only genuine MAGURA brake pads. MAGURA cannot guarantee a correct function of the brake if you use brake pads from other manufacturers, which were not tested. Using other pads might cause poor braking and cause serious injury! All warranty claims will be void in case of misuse!

5. Clean on the occasion of the brake pad change, the brake body with a clean rag. Make sure that the friction side of the new brake pads points towards the rotor.

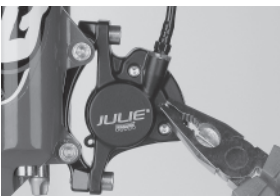

6. Secure the new pads with the new cotter pin, which is delivered, with the pads. Check the correct fitting of the pads by pulling them.



7. Tighten the end of the cotter pin with a screwdriver or pliers. Check the correct fitting of the cotter pin by pulling it.

8. Check, whether the pistons are fully pushed back and whether the pads are flush with the calliper body. Push the brake pads back with the transport device or a flat blade screwdriver as described on page. Re-install the wheel and check for a correctly tightened quick release skewer of the wheel.

9. Squeeze the lever blade several times (pump) to push the pads to their proper position until the lever feel becomes very firm.

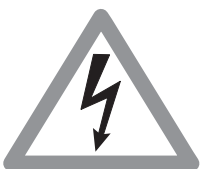

New brakes and/or new rotors or brake pads must always be run in by braking at least 30 times from a speed of 30km/h to achieve the maximum brake power. Take your bike to a safe place to run in the brake.

Never contaminate brake pads with oil or grease this causing permanent loss of brake power! Such contaminated pads can no longer be used and should be replaced!

8. Repairs



disc brake service kit (code: 0721 294)

Don't panic if the hose snaps! With the disc brake service kit and a separately available spare hose (see spare parts pages 21/22), this can be repaired easily.

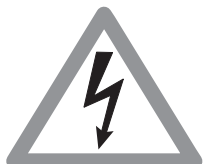

The Julie is a low-pressure system and comes with the same nylon hose that is used on MAGURA rim brakes. Do NOT use the reinforced hose of the other disc brakes with "Disc Tube" label and do NOT mix and match items of different MAGURA disc brakes!" Any misuse might cause serious accidents!

1. Remove the damaged hose from both the brake lever and the calliper. Cut off the barbed adapter (calliper connection) with a sharp knife. Slide both the sleeve nut and hose protector on the other side. All mentioned parts can be re-used. Throw away the damaged hose.

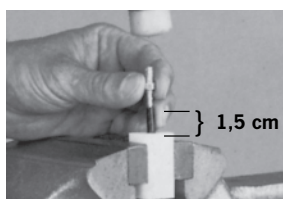

2. Prepare a new hose: the nylon hose of the **Julie** disc brake is identical with the one of the MAGURA rim brakes. Clamp the hose as shown with the help of the two clamping jaws (code: 0321 239) into a vice. Hose has to stick out 1,5cm as shown. Use a nylon mallet to tap the barbed adapter **carefully** into the hose.

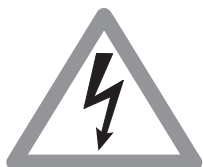

The barbed a dapter must be installed as shown. Never heat up the hose to install the barbed adapter. This might cause the hose to burst with total failure of the complete brake system.

3. Correctly installed barbed adapter.

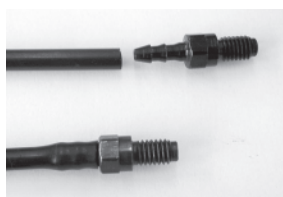

4. Tighten the prepared end of the new hose onto the calliper.
Tightening torque: 4Nm/34 in.lbs.



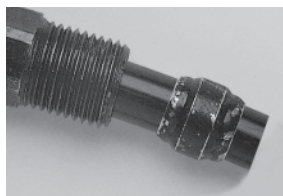

5. Measure the requested length of the hose you need and shorten the hose accordingly with a sharp knife. Slide on the hose protector, sleeve nut and a new olive onto the hose. Push the hose with the new olive **fully** into the brake lever and tighten the sleeve nut with an 8mm open-end wrench.

Tightening torque: 4Nm/34 in.lbs.



After the installation of a new hose you will always have to refill the brake. The following chapter 9 describes who the filling has to be done.



9. Filling and bleeding a brake



Brake Oil: MAGURA disc brakes use as transmission medium low viscosity mineral oil, the biodegradable MAGURA ROYAL BLOOD. Contrary to DOT brake fluid the MAGURA ROYAL BLOOD does not irritate human skin or strip the paint of your frame. Moreover it does not absorb water like DOT and does not have to be changed regularly. What sounds unbelievable is a fact: you can use your brakes over years without having to touch them (except brake pad change!)

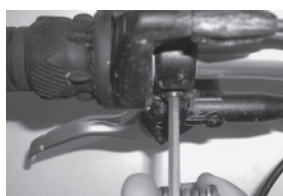

1. Loosen slightly the clamping screw of the brake lever with a 5mm allen key and turn the brake lever so that the reservoir is positioned horizontal. Slightly tighten the **clamp** screw in that position.



2. For filling and bleeding a MAGURA disc brake you will need the disc brake service kit (Code: 0721 294) including all necessary tools.

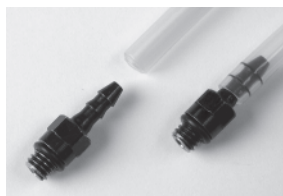

3. Prepare the transparent filler tube by pushing in by hand the M6 barbed fitting. Put the other end of the filler tube on the syringe and fill the syringe **completely** with MAGURA ROYAL BLOOD mineral oil. Fill the syringe completely and make sure that **there are no air bubbles inside**. Turn the syringe eventually to push out air bubbles.



4. Remove the brake pads as described on page 12 and slide the YELLOW transport device as shown **with its THICK END** between the calliper pistons. Squeeze slightly the lever blade (pump) to tighten the transport device. **Only use the YELLOW transport device for this procedure, the formerly used black one is not suitable for this work!**



5. Fix the calliper so that the connecting bolts of the calliper (arrow) are positioned horizontally. **If you do not follow meticulously this advice, a proper bleeding of the brake will fail!** It might be necessary that you have to unscrew the calliper for that or to turn the fork/bike as shown. Unscrew bleeding screw with a 3mm Allen key. Screw in the prepared syringe and tighten it with an open end 8mm spanner.



Place now a rag, which has to be free of oil or lubricants around the reservoir and, more important, around the brake calliper. Care for a clean working environment. No dirt or particles may come into the brake system!



6. Unscrew the Torx T7 reservoir cover screw and remove the cover with the membrane sitting below. Begin to **slowly** press the oil contents of the filling syringe through the system until no further air bubbles can be seen

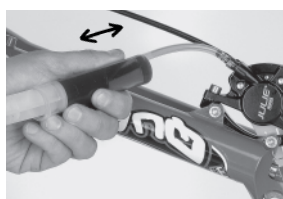

7. Press the MAGURA ROYAL BLOOD oil through the system. Use a second syringe to suck any overflowing oil. at the reservoir. Then pull the filler syringe to suck oil back. Repeat procedure 3-4 times and actuate **CAREFULLY** the lever blade simultaneously. **Make sure that there is always enough oil in the reservoir when you suck the oil with the filling syringe.**



8. Use the second syringe to suck any overflowing oil. The rag around the brake lever and the calliper prevents overflowing oil from dropping down and contaminating and killing the brake pads. Push **the complete contents** of the filling syringe through the system.



9. The reservoir has to be full to the top before replacing the membrane and the cover.



10. Replace the cover with the membrane onto the reservoir. Oil will spill during this procedure therefore do not forget to place a rag around the brake lever. Tighten the cover screw until the cover is flush with the reservoir. **Use only the original Torx T7 bolt. Any other screw will lead to leaks, damages and failure of the whole system! Tightening torque 0,6Nm/5 in.lbs**



11. Remove the syringe and screw in the 3mm allen bleeding screw. **Tightening torque: 2,5Nm/22 in.lbs.** Re-position the brake calliper (**tightening torque 6Nm/51 in. lbs.**). Re-install the brake pads and the wheel.

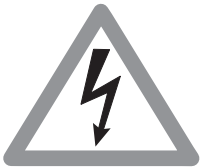

Always pull the lever blade several times (pump) until the brake pads touch the rotor.

Always check for correct installation by activating the lever blade and checking for eventual leaks.

Never contaminate brake pads with oil or grease this causing permanent loss of brake power! Contaminated pads are definitely dead and must be replaced! A contaminated rotor can be cleaned with warm dishwater or alcohol.

10. The disc brake wheel



The XC disc brake wheel

There already exists enough literature concerning wheels, so just a few tips how a well-built X-country disc brake wheel has to be.



Use spokes with a diameter of 2mm (arc)/1,8mm which you cross three times.

No radial lacing with disc brake wheels!

Head-inside-spokes (=arc-outside-spokes have to be pulled, i.e. these spokes point forward on the front wheel; on the back wheel these spokes point forward on the rotor side and backwards on the drive side. All spokes have to be stressed equally and high.



Never use ultra lightweight quick releases with titanium or aluminum axles for your wheel sets in combination with a disc brake. You will not be in a position to realize the necessary tightening torque!

11. Trouble Shooting

problem	reason	solution
not enough brake power no pressure point	brake was not run it	break in the brake (page4)
	oil/lubricants on rotor and/or pads	clean the rotor with warm dishwater or alcohol replace contaminated brake pads
	air in the system	bleeding the brake (page15)
	leaking systems	Correct transport (page 5) Check hose connections and hose for leaks; replace hose if necessary (pages 14/15)
Squealing brake	badly aligned frame	align brake calliper with 0,2mm spacers (page9)
	Paint/powder coating on fitting eyelets	remove any paint or powder coating and care for an even contact surface without burrs. (page7)
	Wheel q/r skewer insuffi- ciently tightened	Increase tightening of q/r skewer and mount it on opposite side of calliper.
	Insufficiently tightened wheel spokes	check for an evenly spoked wheel with high spoke tension
contaminated brake pads	carelessness	brake pads must be changed
contaminated rotor	carelessness	clean rotor with dish water or alcohol
wheel cannot be mounted	Lever blade was pulled with removed wheel	Push back the brake pads with transport device or a flat blade screwdriver. (page12)
rattling noise and rough deceleration	brake pads worn, holder of pads is wearing the rotor	brake pad change (page 12)
leaking hose or brake	accident, incorrect installation	change hose or defective brake lever or calliper (page 14)



You will find further tips on our website www.magura.com in the FAQ section!! Stay tuned.

12. accessories



MAGURA disc brake service kit, code: 0721 294

contains everything that you need for bleeding and repairing a brake.
ATTENTION: the kit does NOT include a spare hose!



MAGURA braided hose for all MAGURA disc brakes

easily shortened with a cable cutter, 1700mm

0° fitting: code 0721 203

90° fitting: code 0721 337

Watch out for the genuine hose with yellow MAGURA marker!!

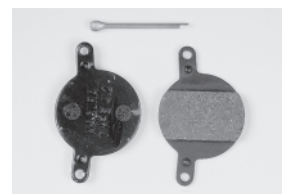

Use only genuine MAGURA brake pads!

brake pads Performance Type 4.1: code 0721 304

series pad for maximum brake power

brake pads Endurance Type 4.2: code 0721 684

series pad for maximum brake power

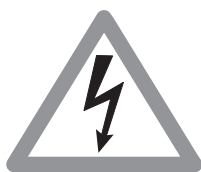

Use only genuine MAGURA accessories! Any parts manufactured by other manufacturers like lever blades, hoses or brake pads have not been tested and approved by MAGURA and consequently nothing can be said about their short and long-term function. Never use those parts! All warranty and product liability claims will be void in case of misuse!

Never change the paint, the finish or the consistence of your brake. This might cause total failure of the whole system with possible heavy bodily injury!

13. Warranty

MAGURA is giving a **5 year leakproof warranty** on brake levers (master cylinder) and brake callipers. Watch out for the red info sheet in the middle of this manual!

This warranty is void when damage to the brake has occurred from the following:

abuse
mixing and matching the brake with parts from other manufacturers
damage of the exterior finish caused by improper use
any attempt to disassemble the whole brake
modifications
non-factory changes or improper service

We expressly point out that a warranty claim is only accepted with a clear proof of purchase (payment receipt of the dealer!) and recommend to register your brake online on magura.com

spare parts 2003/max. tightening torques

Torx T7 key:
0720 847

10x: 0720 927

black with 2-finger lever blade
left 0721557
right 0721556
black with 4-finger lever blade
left 0721 559
right 0721 558

2x: 2-finger alloy, silver
0721317
2x: 4-finger alloy, silver
0721318

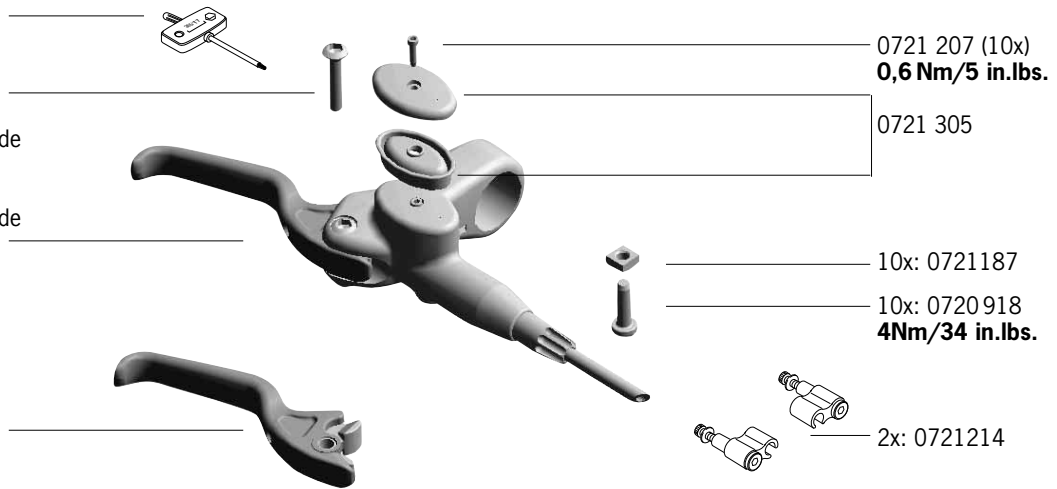

0721 207 (10x)
0,6 Nm/5 in.lbs.

0721 305

10x: 0721187

10x: 0720918
4Nm/34 in.lbs.

2x: 0721214

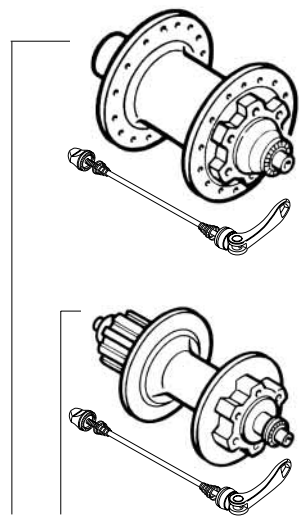

hubs

Pro S:
front/silver 0150 035
front/black 0150 037
rear/silver 0150 036
rear/black 0150 038
Comp:
front/silver 0721 148
front/black 0721 155
rear/silver 0721 149
rear/black 0721 156
Fun:
front/black 0721 355
rear/black 0721 357

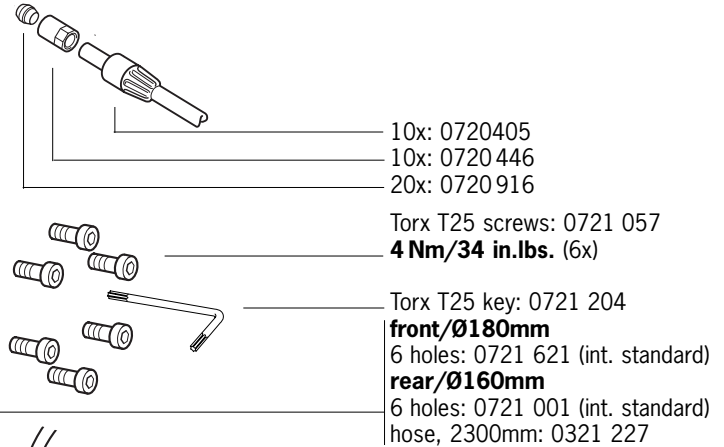
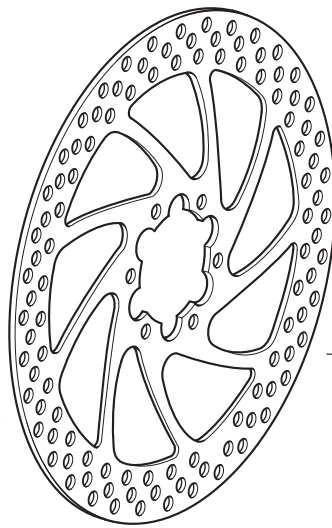

10x: 0720405
10x: 0720 446
20x: 0720 916

Torx T25 screws: 0721 057
4 Nm/34 in.lbs. (6x)

Torx T25 key: 0721 204
front/Ø180mm
6 holes: 0721 621 (int. standard)
rear/Ø160mm
6 holes: 0721 001 (int. standard)
hose, 2300mm: 0321 227

braided hose 0°
1700mm: 0721 203
2500mm: 0721 386
6 Nm/51 in.lbs.

10x: 0720 411/**4 Nm/34 in.lbs.**

10x: 0720 931
2,5Nm/22 in.lbs.

6Nm/51 in.lbs.

calliper Postmount 74 (black)
0721 563

Quickmount cpl.
0721 694/ **6 Nm/51 in.lbs.**

0721 304 (2x)
Type 4.1 Performance
0721 684 (2x)
Type 4.2 Endurance

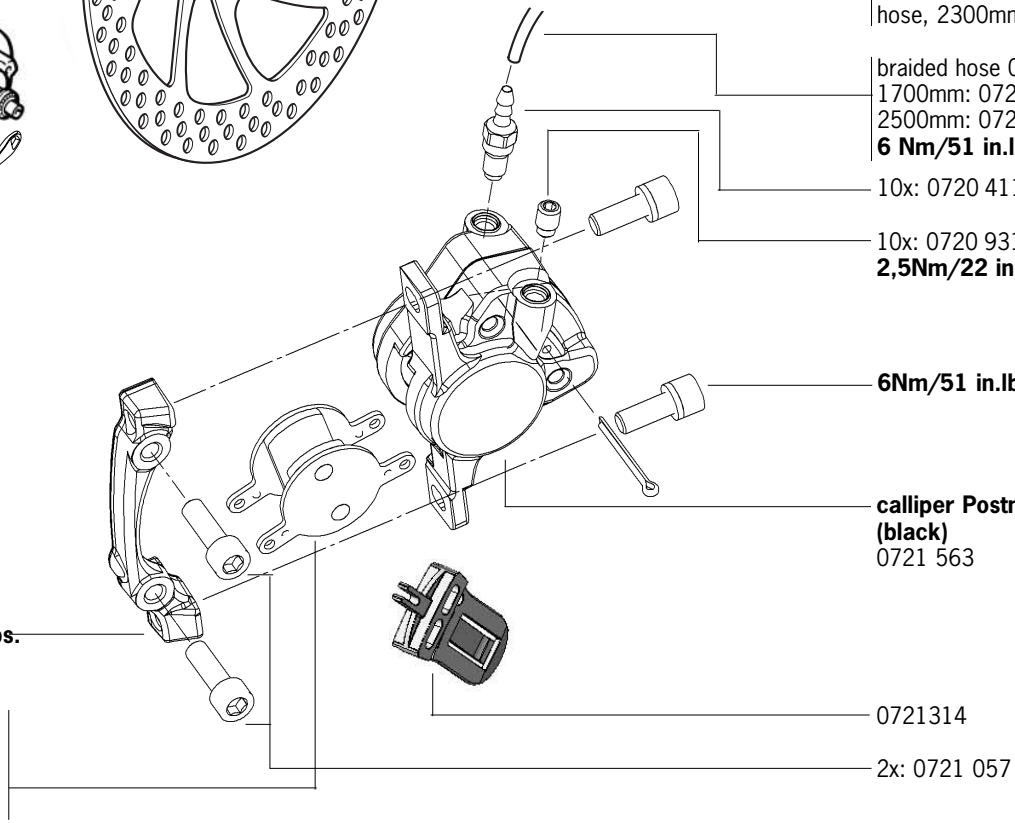

0721314

2x: 0721 057



MAGURA Bike Parts GmbH & Co.
Heinrich Kahn Straße 24
D-89150 Laichingen
phone +49-(0)7333/9626-0
fax +49-(0)7333/9626-17
info@magura-bikeparts.de

Hotline/Helpdesk:
phone +49-(0)7125/153-180
daily 9-12h and 13-16h CET
fax +49-(0)7125/153-184
service@magura.de

**MAGURA Partners and Service
Centers Worldwide**

Andorra Esports Jorma
phone 376-844133
fax 376-843022
jorma@correu.andornet.ad

Australia TMO Sports
phone 02-9695-7744
fax 02-9695-7844
service@velovita.com.au

Austria Funbike
phone 0662-6362450
fax 0662-6362455
funbike@funbike.at

Belgium Transmission
phone 010-244646
fax 010-244777
info@transmission.be

Canada MAGURA USA
phone 618-3952200
fax 618-3954711
magura@magurausa.com

Czech Republic
Vanek Praha
phone 0312-698016
fax 0312-698025
tomas.kubin@vanekpraha.cz

Denmark Borandia APS
phone 47-107172
fax 47-107066
borandia@borandia.dk

Finland Best Brakes Ky
phone 050-591 5863
fax 019-388485
info@bestbrakes.inet.fi

France MAGURA Service-Center France
(seulement SAV via détaillants!)
phone +49 7125-153 290
fax +49 7125-153 184
sav_france@magura.de
Maillon
phone 05-56386300
fax 05-56386301
maillon.sarl@wanadoo.fr
Cycles Lapierre
phone 03-80525186
fax 03-80520851
florian.robin@cycles-lapierre.fr

Great Britain
MAGURA Bike Parts UK Ltd.
phone: 01530-837195
fax: 01530-811286
service_uk@magura.com

Greece Nikos Maniatopoulos
phone 061-993045
fax 061-990424
idealman@hol.gr

Hong Kong MAGURA ASIA Inc.
phone +886-4-23283739
fax +886-4-23283734
service@magura.com.tw

Hungary Mali Bicycle Technology
phone 01-4207563
fax 01-4205321
mali@mali.hu

Ireland Beara Bike Trading
phone 064-89134
fax 064-41334
wschmidt@indigo.ie

Israel R.S. Sport
phone 0972-99584174
fax 0972-99584174
lironl@rssport.com

Italy Weinert
phone 0421-81217
fax 0421-83680
weinert@iol.it

Japan MC International
phone 06-6536-0901
fax 06-6536-0907
mcinter@mx1.alpha-web.ne.jp

Korea MAGURA ASIA Inc.
phone +886-4-23283739
fax +886-4-23283734
service@magura.com.tw

Luxemburg Transmission
phone 0032-10-244646
fax 0032-10-244777
info@transmission.be

Netherlands NZ Parts
phone 010-2340468
fax 010-2340824
nzparts@worldonline.nl

Norway Botolfsen
phone 022-630610
fax 022-970662
info@botolfsen.no

Portugal LPL-Artigos Desportivos
phone 021-4835354
fax 021-4835362
lpl@netcabo.pt

Singapore MAGURA ASIA Inc.
phone +886-4-23283739
fax +886-4-23283734
service@magura.com.tw

Slovenia Factory Store
phone 06-3481705
fax 06-3481705
factorystore@siol.net

South Africa Cycles Africa
phone 011-678-1548
fax 011-678-1548
cunning@mweb.co.za

Spain SAT MAGURA: Bicisport
Sólo para reparaciones y servicio!
phone: 93 3404480
fax: 93 3404480
Bicicletas Monty
phone 93-6667111
fax 93-6667112
monty@monty.es

Spain Casa Masferrer
phone 93-8463444
fax 93-8465355
cmcenter@casamasferrer.com
Comet
phone 943-331393
fax 943-551407
comet@comet.es

Representaciones Spinola & Perez
phone 619-702946
fax 93-2317731
c.perez@spinolaperez.com

Sweden Jaguarverken AB
phone 060-669800
fax 060-669809
info@jaguarverken.se

Switzerland Intercycle
phone 041-9266511
fax 041-9266355
info@intercycle.com

Amsler & Co.
phone 052-6473636
fax 052-6473637
info@amsler.ch
Taiwan MAGURA ASIA Inc.
phone 04-23283739
fax 04-23283734
service@magura.com.tw

USA MAGURA USA
phone 6183952200
fax 6183954711
magura@magurausa.com
www.magurausa.com