



# Front Drive System

## General Safety Information

### **⚠ WARNING**

- The ST-M600 DUAL CONTROL lever is used for both gear shifting and braking operations. Make sure that you fully understand and are accustomed to the gear shifting and braking operations for your bicycle. Refer to the illustration for the method of operation.
- Braking can only be performed with the DUAL CONTROL lever. If you use the gear shifting release lever (Auxiliary release lever) for braking, the release lever may become damaged and you may lose control of the bicycle, which could result in an accident.
- If the internal unit of the DUAL CONTROL lever becomes damaged, the lever will move down from the normal lever position, and it may move to a position where braking is difficult to carry out. If this happens, you should stop riding the bicycle immediately.
- Use neutral detergent to clean the chain. Do not use alkali-based or acid based detergent such as rust cleaners as it may result in damage and/or failure of the chain.
- Use the reinforced connecting pin only for connecting the narrow type of chain.
- There are two different types of reinforced connecting pins available. Be sure to check the table below before selecting which pin to use. If connecting pins other than reinforced connecting pins are used, or if a reinforced connecting pin or tool which is not suitable for the type of chain is used, sufficient connection force may not be obtained, which could cause the chain to break or fall off.
- If it is necessary to adjust the length of the chain due to a change in the number of sprocket teeth, make the cut at some other place than the place where the chain has been joined using a reinforced connecting pin or an end pin. The chain will be damaged if it is cut at a place where it has been joined with a reinforced connecting pin or an end pin.
- Be careful not to let the cuffs of your clothes get caught in the chain while riding, otherwise you may fall off the bicycle.
- Check that the tension of the chain is correct and that the chain is not damaged. If the tension is too weak or the chain is damaged, the chain should be replaced. If this is not done, the chain may break and cause serious injury.
- Use a front chainwheel which is compatible with 9-speed chains in conjunction with Shimano CN-7701, CN-HG93 and CN-HG73 chains. If a chainwheel for an 8-speed chain or less is used, front chainwheel gear shifting problems may occur, or the chain pins might fall out, causing the chain to break.
- Check that there are no cracks in the crank arms before riding the bicycle. If there are any cracks, the crank arm may break and you may fall off the bicycle.
- Obtain and read the service instructions carefully prior to installing the parts. Loose, worn, or damaged parts may cause injury to the rider.  
We strongly recommend only using genuine Shimano replacement parts.
- Read these Technical Service Instructions carefully, and keep them in a safe place for later reference.

Chain	Reinforced connecting pin	Chain tool
9-speed super narrow chain such as CN-7701 / CN-HG93	Silver 6.5mm	TL-CN31 / TL-CN22
8-/7-/6-speed narrow chain such as CN-HG50 / CN-IG51	Black 7.1mm	TL-CN31 / TL-CN22 and TL-CN30 / TL-CN21

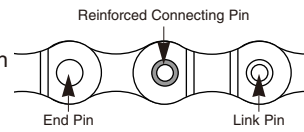

### Note

- In addition, if pedaling performance does not feel normal, check this once more.
- Check that there is no looseness in any joints or connections before riding the bicycle. (BB-FC, FC-PD)
- Do not wash the bottom bracket with high-pressure jets of water.
- If you feel any looseness in the bottom bracket axle, the bottom bracket should be replaced.
- If gear shifting operations do not feel smooth, wash the derailleur and lubricate all moving parts.
- If the amount of looseness in the links is so great that adjustment is not possible, you should replace the derailleur.
- You should periodically wash the chainrings in a neutral detergent and then lubricate them again. In addition, cleaning the chain with neutral detergent and lubricating it can be an effective way of extending the useful life of the chainrings and the chain.
- If the chain keeps coming off the chainrings during use, replace the chainrings and the chain.
- When the chain is in the position shown in the illustration, the chain may contact the front chainrings or front derailleur and generate noise. If the noise is a problem, shift the chain onto the next-larger rear sprocket or the one after.
- Apply grease to the bottom bracket before installing it.
- For smooth operation, use the specified outer casing and the bottom bracket cable guide.
- This front derailleur is for triple front chainwheel use only. It cannot be used with the double front chainwheel, as the shifting points do not match.
- When installing the top route type, choose a frame that has three outer casing holders as shown in the illustration at right.
- Use an outer casing which still has some length to spare even when the handlebars are turned all the way to both sides. Furthermore, check that the shifting lever does not touch the bicycle frame when the handlebars are turned all the way.
- Make sure that the gear shifting cable and the brake cable do not obstruct each other during braking operations. If they do obstruct, it may interfere with braking.  
Install the cables so that they still have some slack in them even when the handlebars are turned fully in either direction.

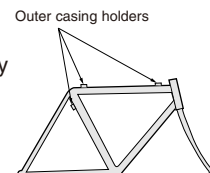
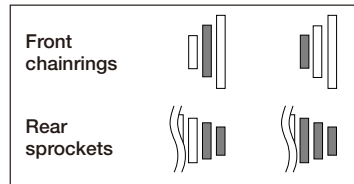

- A special grease is used for the gear shifting cable (SIS-SP41). Do not use DURA-ACE grease or other types of grease, otherwise they may cause deterioration in gear shifting performance.
- Grease the inner cable and the inside of the outer casing before use to ensure that they slide properly.
- Operation of the levers related to gear shifting should be made only when the front chainwheel is turning.
- If the brake fluid used in the oil disc brakes is of a type which tends to adhere to the plastic parts of the shifting lever, this may cause the plastic parts to crack or become discolored. Therefore, you should make sure that the brake fluid does not adhere to these plastic parts.  
The mineral oil which is used in SHIMANO disc brakes does not cause cracking or discoloration if it adheres to plastic parts, but such parts should be cleaned with alcohol beforehand to prevent foreign particles from adhering.
- Parts are not guaranteed against natural wear or deterioration resulting from normal use.
- For maximum performance we highly recommend Shimano lubricants and maintenance products
- For any questions regarding methods of installation, adjustment, maintenance or operation, please contact a professional bicycle dealer.

In order to realize the best performance, we recommend that the following combination be used.

Series	HONE
DUAL CONTROL lever	ST-M600
Outer casing	SIS-SP41
Front derailleur	FD-M600 / FD-M601
Front chainwheel	FC-M600
Chain	CN-HG73
Bottom bracket cable guide	SM-SP17 / SM-BT17

## Specifications

### Front Derailleur

X = Available

Model number	FD-M600 / FD-M600-E	FD-M601
Normal type	X	X
Top route type	X	X
Front chainwheel tooth difference	22T	22T
Min. difference between top and intermediate	12T	12T
Front derailleur installation band diameter	S, M, L	S, M, L
Chainstay angle ( $\alpha$ )	66° - 69°	66° - 69°
Applicable chain line	50.0mm	50.0mm
Applicable front chainwheel	44T	44T

#### Installation band diameters:

S (28,6 mm), M (31,8 mm), L (34,9 mm)

When using the S, M size, use an installation band with a diameter of 28.6 mm, 31.8mm and install it to a L size adapter.

Chainstay angle

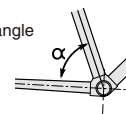

### Chainwheel

Model number	FC-M600
Chainwheel tooth combination	44-32-22T
Bolt circle diameter	104 mm / 64 mm
Crank arm length	170 mm, 175 mm
Chain line	50 mm
Shell width	68, 73 mm
Thread dimensions	BC1.37 (68, 73mm)

## Operating the levers

### ■ Operating the brake lever

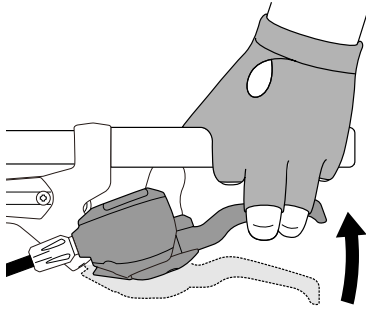

### Adjusting the grip width

It is recommended that you adjust the grip widths of the levers to the most comfortable widths for gear shifting and braking.

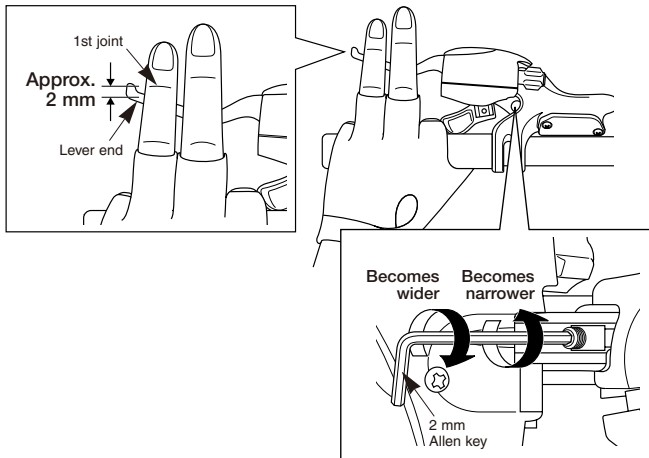

### ■ Gear shifting operation

The lever always returns to the initial position when it is released after shifting. When operating the lever, always be sure to turn the crank arm at the same time.

#### To shift from a small chainring to a larger chainring

When lever is pressed once, there is a shift of one step from a small chainring to a larger chainring.

#### Example:

from intermediate chainring to largest chainring.

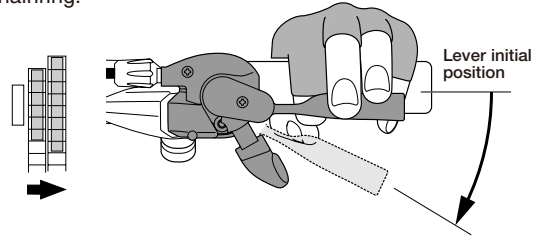

#### To shift from a large chainring to a smaller chainring

When lever is pressed once, there is a shift of one step from a large chainring to a smaller chainring.

#### Example:

from largest chainring to intermediate chainring.

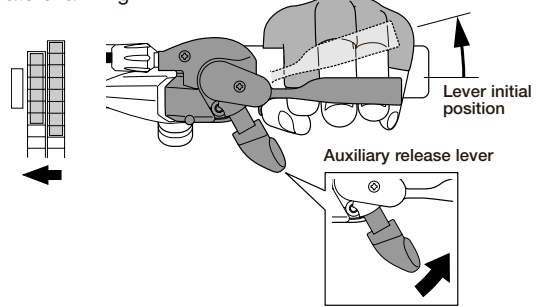

# Installation of the Front Chainwheel and Front Derailleur

Follow the procedure in the figure.

- 1, 2 Use the special tool TL-FC32 to install the right adapter (counterclockwise thread) and the left adapter (clockwise thread).  
Tightening torque: 35 - 50 N·m {305 - 435 in. lbs.}
- 3 Insert the right crank unit.
- 4 Set section A of the left crank into the axle of the right crank unit where the groove is wide.
- 5 Use the TL-FC16 to tighten the cap.  
Tightening torque: 0.7 - 1.5 N·m {6 - 13 in. lbs.}
- 6 Tighten the bolt of the left crank.  
**Note :** Each of the bolts should be evenly and equally tightened to 12 - 15 N·m {106 - 132 in. lbs.}.

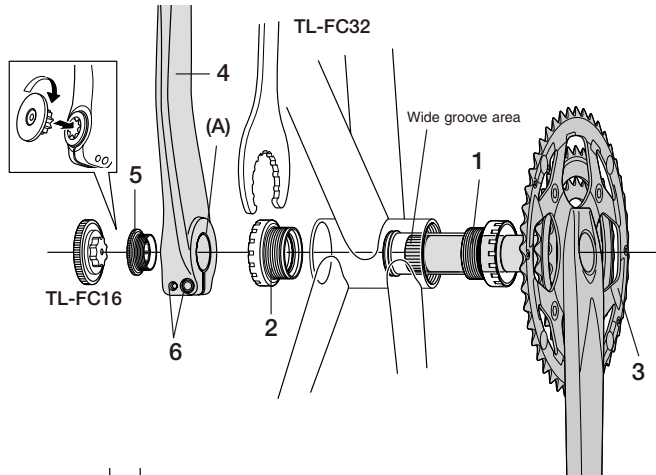

## ■ Spacer installation method

- (1) Check whether the width of the bottom bracket shell is 68 mm or 73 mm.
- (2) Next, install the adapter while referring to the illustrations below.

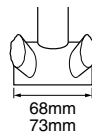

### 68 mm (Band Type)

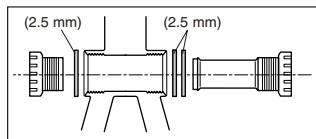

### 68 mm (Bracket Type)

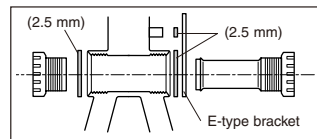

### 73 mm (Band Type)

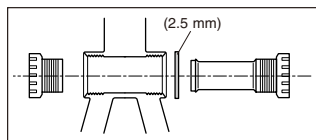

### 73 mm (Bracket Type)

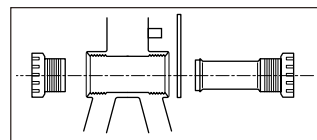

### For bracket type

Install as shown in the illustration.

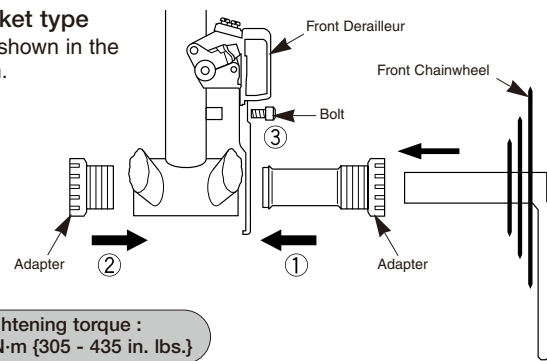

Adjust and then install the front derailleur as shown in the illustration. Do not remove the Pro-Set alignment block at this time.

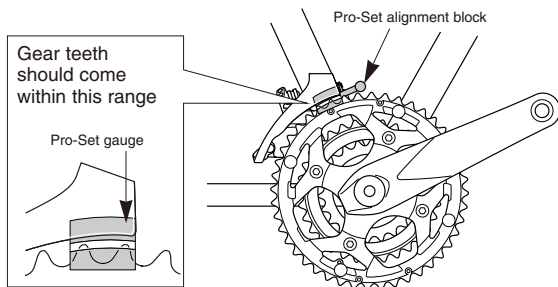

The level section of the chain guide outer plate should be directly above and parallel to the largest chainring. Secure using a 5 mm Allen key.

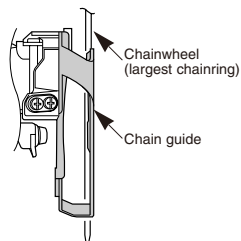

Tightening torque :  
5 - 7 N·m {44 - 60 in. lbs.}

## Chain length

Add 2 links (with the chain on both the largest sprocket and the largest chainring)

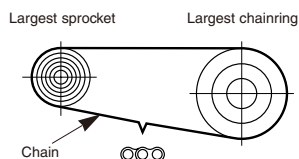

## Installation of the lever

Use a handlebar grip with a maximum outer diameter of 32 mm.

**Tightening torque :**  
6 - 8 N·m {53 - 69 in. lbs.}

In the case of carbon handlebars, it may be necessary to lower the tightening torque in order to prevent damage to the handlebar. Please consult the bicycle or handlebar manufacturer regarding the appropriate level of tightening torque for carbon handlebars.

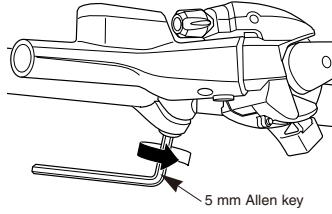

## SIS Adjustment

Be sure to follow the sequence described below.

### 1. Low adjustment

First remove the Pro-Set alignment block .

Next, set so that the clearance between the chain guide inner plate and the chain is 0 - 0.5 mm.

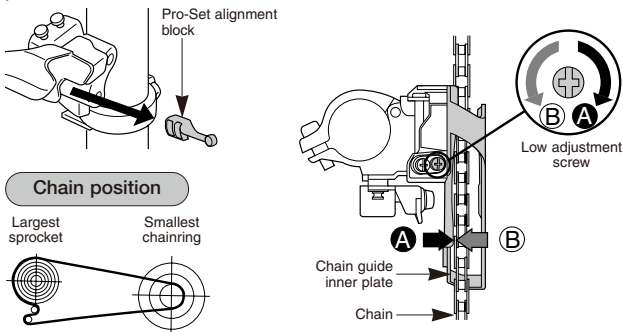

### 2. Connecting and securing the inner cable

Operate the lever 2 or more times to set the lever to the low position. After removing the cover, place the end of the cable onto the hook. In this condition, operate the lever 2 or more times to set the lever to the top position, and then pass the cable through the outer casing adjustment bolt and pull the cable all the way through. After this, operate the lever to set it to the low position and install the cover.

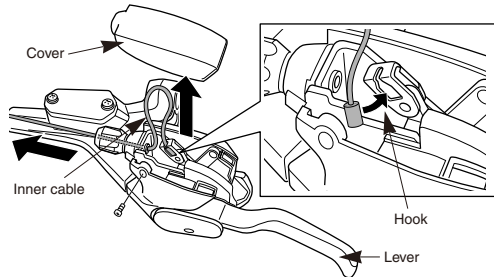

### Cutting the outer casing

When cutting the outer casing, cut the opposite end to the end with the marking. After cutting the outer casing, make the end round so that the inside of the hole has a uniform diameter.



Attach the same outer end cap to the cut end of the outer casing.

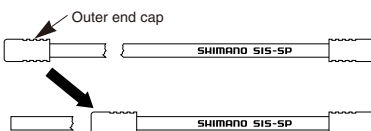

• FD-M600

< Normal type >

< Top route type >

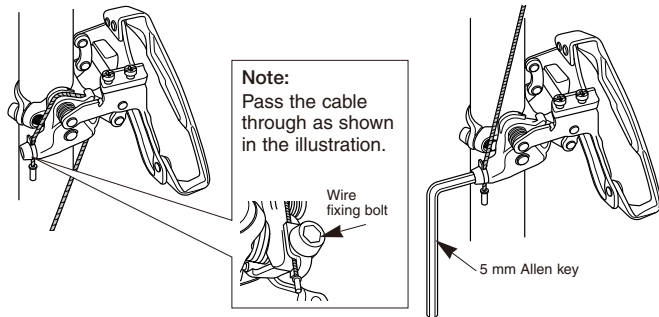

• FD-M601

< Normal type >

< Top route type >

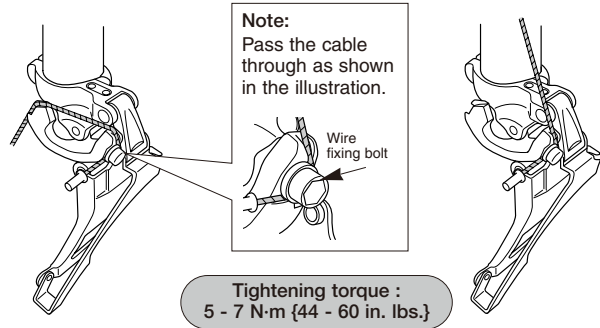

After taking up the initial slack in the cable, re-secure to the front derailleur as shown in the illustration.

Normal type

Top route type

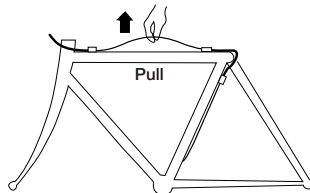
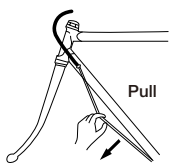

3. Top adjustment

Set so that the clearance between the chain guide outer plate and the chain is 0 - 0.5 mm.

Chain position

Smallest sprocket      Largest chainring

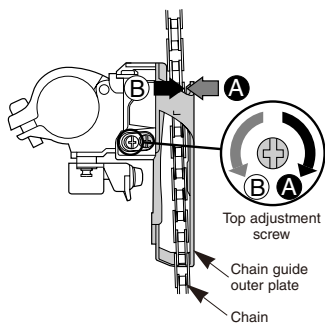
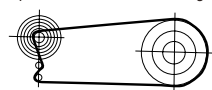

4. Adjustment of the intermediate chainring

When carrying out adjustment, set the chain to the largest sprocket, and at the front, set the chain to the intermediate chainring. Adjust using the outer casing adjustment barrel so that the clearance between the chain guide inner plate and the chain is 0 - 0.5 mm.

Chain position

Largest sprocket      Intermediate chainring

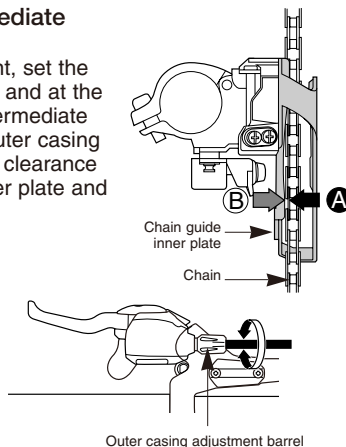
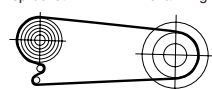

## 5. Troubleshooting chart

After completion of steps 1 - 4, move the shifting lever to check the shifting. (This also applies if shifting becomes difficult during use.)

If the chain falls to the crank side.	Tighten the top adjustment screw clockwise (about 1/4 turn).
If shifting is difficult from the intermediate chainring to the largest chainring.	Loosen the top adjustment screw counterclockwise (about 1/8 turn).
If shifting is difficult from the intermediate chainring to the smallest chainring.	Loosen the low adjustment screw counterclockwise (about 1/4 turn).
If there is interference between the chain and the front derailleur inner plate at the largest chainring.	Tighten the top adjustment screw clockwise (about 1/8 turn).
If there is interference between the chain and the front derailleur outer plate at the largest chainring.	Loosen the top adjustment screw counterclockwise (about 1/8 turn).
If the intermediate chainring is skipped when shifting from the largest chainring.	Loosen the outer casing adjustment barrel counterclockwise (1 or 2 turns).
If there is interference between the chain and front derailleur inner plate when the rear sprocket is shifted to the largest sprocket when the chainwheel is at the intermediate chainring position.	Tighten the outer casing adjustment barrel clockwise (1 or 2 turns).
If the chain falls to the bottom bracket side.	Tighten the low adjustment screw clockwise (about 1/2 turn).
If the lever is stiff when shifting from the intermediate chainring to the largest chainring	Loosen the top adjustment screw counterclockwise (about 1/4 turn).

This service instruction explains how to use and maintain the Shimano bicycle parts which have been used on your new bicycle. For any questions regarding your bicycle or other matters which are not related to Shimano parts, please contact the place of purchase or the bicycle manufacturer.

## SHIMANO

SHIMANO AMERICAN CORPORATION  
One Holland, Irvine, California 92618, U.S.A. Phone: +1-949-951-5003

SHIMANO EUROPE HOLDING B.V.  
Industrieweg 24, 8071 CT Nunspeet, The Netherlands Phone: +31-341-272222  
Please note: specifications are subject to change for improvement without notice. (English)  
© May, 2004 by Shimano Inc. XBC SZK Printed in Japan

SHIMANO INC.  
3-77 Oimatsu-cho, Sakai, Osaka 590-8577, Japan

