

# Integrated Headset (CA)

## NO.44E

1-1/8" / 1-1/4", 45° / 45° ACB

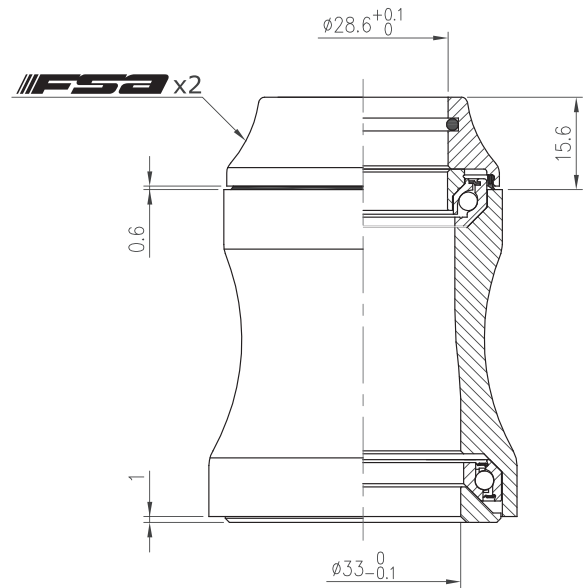
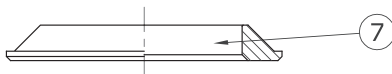
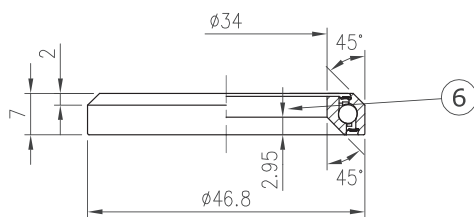
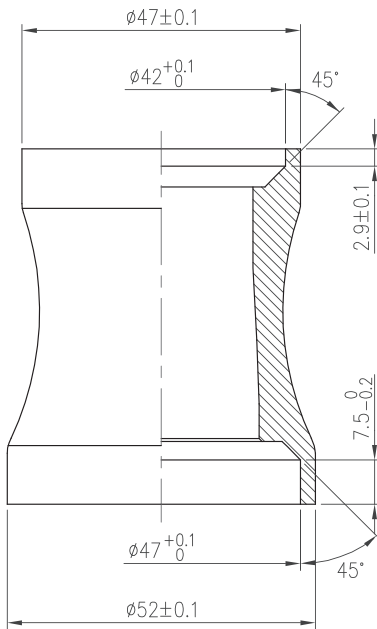
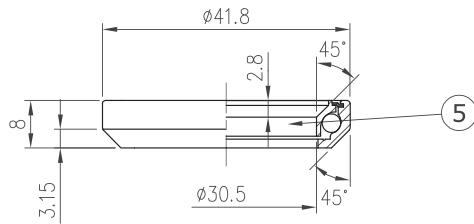
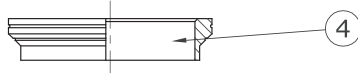
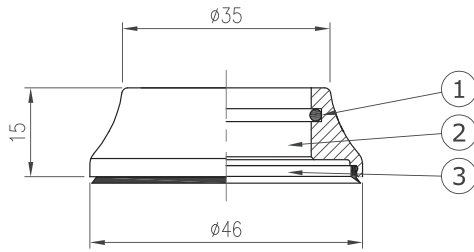

Stack Height 15.6+1=16.6

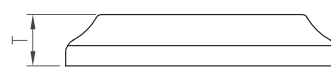

Custom cone spacer		
Item No	T	Stack Height
H2166A	8.7mm	10.3mm
H2166C	20mm	21.6mm



Weight - 74 grams

- For tapered 47mm / 52mm OD head tube
- For 1-1/8" to 1-1/4" tapered fork
- Alloy top cover
- Upper : Angular Contact Bearing (Black seal)
- Lower : 1-1/4" Angular Contact Bearing (Black seal)

No	Item No	Material	Qty
⑦	H6063{NO.44-6}	Alloy	1PCS
⑥	MR168{970E-RS}	Chrome steel	1SET
⑤	MR121{870E-RS}	Chrome steel	1SET
④	H2081A{NO.8-2}	Alloy	1PCS
③	MS100	Steel w/ rubber sealed	1PCS
②	H2166B{NO.8-2}	Alloy	1PCS
①	MS053{872}	Rubber	1PCS

