



# Front Drive System

## General Safety Information

### ⚠ WARNING

- Use neutral detergent to clean the chain. Do not use alkali-based or acid based detergent such as rust cleaners as it may result in damage and/or failure of the chain.
- Use the reinforced connecting pin only for connecting the narrow type of chain.
- There are two different types of reinforced connecting pins available. Be sure to check the table below before selecting which pin to use. If connecting pins other than reinforced connecting pins are used, or if a reinforced connecting pin or tool which is not suitable for the type of chain is used, sufficient connection force may not be obtained, which could cause the chain to break or fall off.

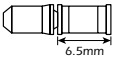
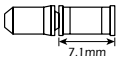
Chain	Reinforced connecting pin	Chain tool
9-speed super narrow chain such as CN-7701 / CN-HG93	 Silver	TL-CN31/TL-CN22
8- / 7- / 6-speed narrow chain such as CN-HG50 / CN-IG51	 Black	TL-CN31/TL-CN22 and TL-CN30/TL-CN21

- If it is necessary to adjust the length of the chain due to a change in the number of sprocket teeth, make the cut at some other place than the place where the chain has been joined using a reinforced connecting pin or an end pin. The chain will be damaged if it is cut at a place where it has been joined with a reinforced connecting pin or an end pin.

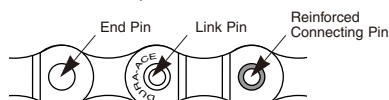

- Be careful not to let the cuffs of your clothes get caught in the chain while riding, otherwise you may fall off the bicycle.
- Check that the tension of the chain is correct and that the chain is not damaged. If the tension is too weak or the chain is damaged, the chain should be replaced. If this is not done, the chain may break and cause serious injury.
- Check that there are no cracks in the crank arms before riding the bicycle. If there are any cracks, the crank arm may break and you may fall off the bicycle.
- Obtain and read the service instructions carefully prior to installing the parts. Loose, worn, or damaged parts may cause injury to the rider. We strongly recommend that only genuine Shimano replacement parts be used.
- Read these Technical Service Instructions carefully, and keep them in a safe place for later reference.

### ⚠ CAUTION

- **Use a front chainwheel which is compatible with 9-speed chains in conjunction with Shimano CN-7701, CN-HG93 and CN-HG73 chains. If a chainwheel for an 8-speed chain or less is used, front chainwheel gear shifting problems may occur, or the chain pins might fall out, causing the chain to break.**

### Note

- In addition, if pedaling performance does not feel normal, check this once more.
- Check that there is no looseness in any joints or connections before riding the bicycle. (BB-FC, FC-PD)
- Do not wash the bottom bracket with high-pressure jets of water.
- If you feel any looseness in the bottom bracket axle, the bottom bracket should be replaced.
- If gear shifting operations do not feel smooth, wash the derailleur and lubricate all moving parts.
- If the amount of looseness in the links is so great that adjustment is not possible, you should replace the derailleur.
- You should periodically wash the sprockets in a neutral detergent and then lubricate them again. In addition, cleaning the chain with neutral detergent and lubricating it can be an effective way of extending the useful life of the sprockets and the chain.
- If the chain keeps coming off the sprockets during use, replace the sprockets and the chain.
- Apply grease to the bottom bracket before installing it.
- For smooth operation, use the specified outer casing and the bottom bracket cable guide.

- This front derailleur is for triple front chainwheel use only. It cannot be used with the double front chainwheel, as the shifting points do not match.
- When installing the top route type, choose a frame that has three outer casing holders as shown in the illustration at right.
- Use an outer casing which still has some length to spare even when the handlebars are turned all the way to both sides. Furthermore, check that the shifting lever does not touch the bicycle frame when the handlebars are turned all the way.
- Grease the inner cable and the inside of the outer casing before use to ensure that they slide properly.
- Be sure to use only the applicable chain and bottom bracket.
- If using a chain case, use the FC-M510-K / BB-ES50-K / FC-M510-KO / BB-ES51-K combination.
- Operation of the levers related to gear shifting should be made only when the front chainwheel is turning.
- Parts are not guaranteed against natural wear or deterioration resulting from normal use.
- For maximum performance we highly recommend Shimano lubricants and maintenance products
- For any questions regarding methods of installation, adjustment, maintenance or operation, please contact a professional bicycle dealer.

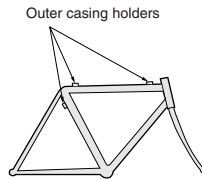

### FD-M510 Adjustment Bolts

Because of the different construction of the new link, the positions of the top and low adjustment bolts on the FD-M510 are reversed from the positions on previous front derailleurs.

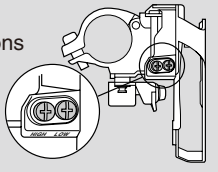

In order to realize the best performance, we recommend that the following combination be used.

Series	DEORE		
Rapidfire M9 (Shifting lever)	ST-M510 / SL-M510		
Outer casing	SP40 sealed		
Front derailleur	FD-M510 / FD-M511		
Front chainwheel	FC-M510	FC-M510 (OCTALINK)	FC-M445 (OCTALINK)
Bottom bracket	BB-UN25	BB-ES51	
Chain	CN-HG73		
Bottom bracket cable guide	SM-SP17 / SM-BT17		

## Specifications

### Front Derailleur

Model number	FD-M510 / FD-M511
Applicable to both normal type and top route type	○
Front chainwheel tooth difference	22T
Min. difference between top and intermediate	12T
Front derailleur installation band diameter	S, M, L
Chainstay angle ( $\alpha$ )	63° - 66°, 66° - 69°
Applicable chain line	47.5mm, 50.0mm
Applicable Bottom Bracket	BB-UN25 / BB-ES51

Installation band diameters:  
S (28,6 mm), M (31,8 mm), L (34,9 mm)  
(Use the adapter for S and M sizes.)

Chainstay angle

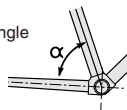

### Chainwheel

Model number	FC-M510	FC-M510 (OCTALINK)	FC-M445 (OCTALINK)
Chainwheel tooth combination	44-32-22T		
Bolt circle diameter	104 mm / 64 mm		
Crank arm length	170 mm, 175 mm		
Pedal thread dimensions	BC 9/16" x 20 T.P.I.		
Applicable Bottom Bracket	BB-UN25	BB-ES51	

## Bottom Bracket

Model number	BB-UN25		BB-ES51			
	MM 110	LL 113	—		—	
Stamped marking	MM 110	LL 113	—		—	
Spindle length	110 mm	113 mm	113 mm	118 mm	121 mm	126 mm
Chain line	47.5 mm	50 mm	47.5 mm	50 mm	47.5 mm	50 mm
Shell width	68, 73 mm	68, 73 mm	68, 73 mm		68 mm	73 mm
Thread dimensions	BC1.37 (68,73 mm)	BC1.37 (68,73 mm)	BC1.37 (68,73 mm)	BC1.37 (68,73 mm)		

## Installation of the Front Derailleur, Bottom Bracket and Front Chainwheel

Install using the special tool TL-UN74-S.

First install the main body, then the adapter.

Adapter / bottom bracket  
tightening torque :  
50 - 70 N·m {435 - 608 in. lbs.}

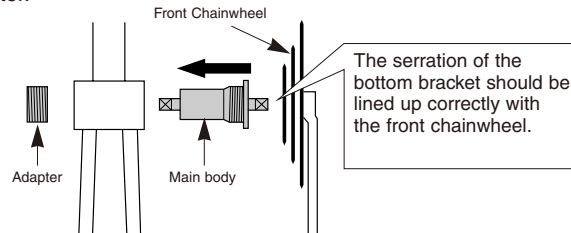

Use an 10 mm Allen key to install the front chainwheel.

Front chainwheel tightening torque :  
35 - 50 N·m {305 - 435 in. lbs.}

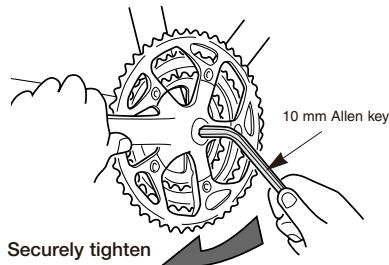

The level section of the chain guide outer plate should be directly above and parallel to the largest chainring. Secure using a 5 mm Allen key.

Tightening torque :  
5 - 7 N·m {44 - 60 in. lbs.}

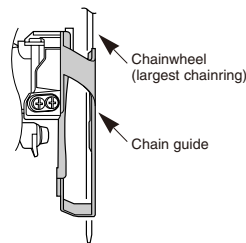

Adjust and then install the front derailleur as shown in the illustration. Do not remove the Pro-Set alignment block at this time.

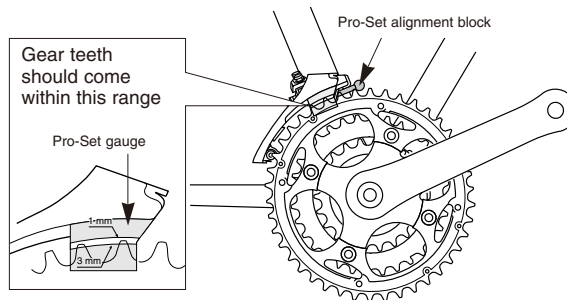

## Chain length

Add 2 links (with the chain on both the largest sprocket and the largest chainring)

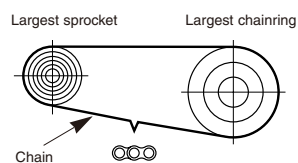

## Mounting the shifting lever

Use a handlebar grip with a maximum outer diameter of 32 mm.

### SL-M510

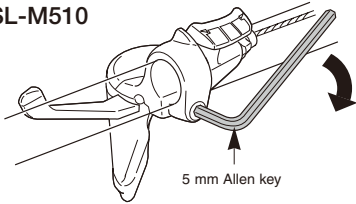

Tightening torque :  
5 N·m {44 in. lbs.}

Install the brake lever in a position where it will not obstruct brake operation. Do not use in a combination which causes brake operation to be obstructed.

### ST-M510

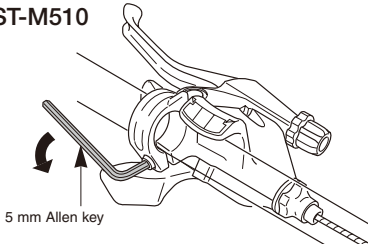

Tightening torque :  
6 - 8 N·m {53 - 69 in. lbs.}

## SIS adjustment

Be sure to follow the sequence described below.

### 1. Low adjustment

First remove the Pro-Set alignment block .

Next, set so that the clearance between the chain guide inner plate and the chain is 0-0.5 mm.

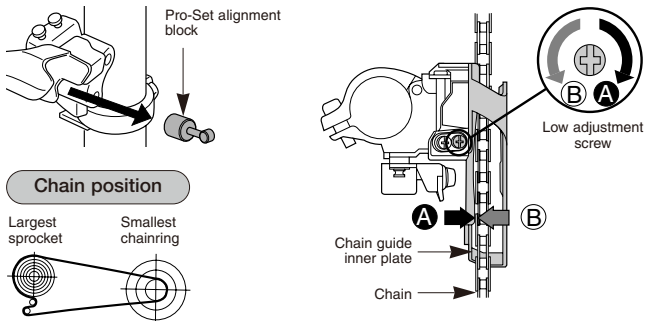

### 2. Connecting and securing the inner cable

Operate lever (B) 2 or more times, check on the indicator that the low position is correct, and then secure the inner cable.

While firmly pulling the inner cable, secure by tightening the fixing bolt with a 5 mm Allen key.

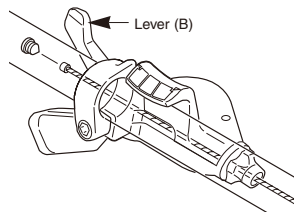

Tightening torque :  
5 - 7 N·m {44 - 60 in. lbs.}

Install the inner hole cover by turning it as shown in the illustration until it stops.

Do not turn it any further than this, otherwise it may damage the screw thread.

In addition, if the unit cover becomes bent, it may cause the unit cover to get in the way of the feed lever and prevent the feed lever from operating correctly.

If the feed lever does not return correctly, loosen the inner hole cover slightly, and then move the feed lever and the unit cover apart and check if this improves the returning of the feed lever.

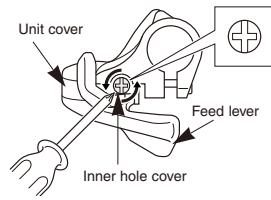

**Tightening torque :**  
0.3 - 0.5 N·m {3 - 4 in. lbs.}

### Inserting the inner cable

Insert the inner cable into the outer casing from the end with the marking on it. Apply grease from the end with the marking in order to maintain cable operating efficiency.

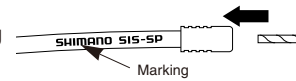

### Cutting the outer casing

When cutting the outer casing, cut the opposite end to the end with the marking. After cutting the outer casing, make the end round so that the inside of the hole has a uniform diameter.



Attach the same outer end cap to the cut end of the outer casing.

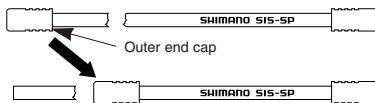

Cut off the excess length of inner cable and then install the inner end cap.

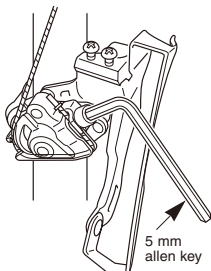

Top route type

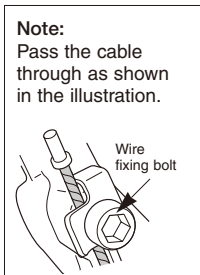

Normal type

**Note:**  
Pass the cable through as shown in the illustration.

Wire fixing bolt

**Tightening torque :**  
5 - 7 N·m {44 - 60 in. lbs.}

After taking up the initial slack in the cable, re-secure to the front derailleur as shown in the illustration.

Normal type

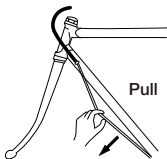

Top route type

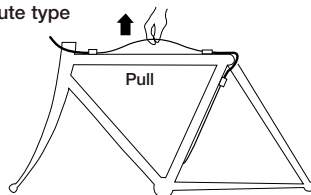

### 3. Top adjustment

Set so that the clearance between the chain guide outer plate and the chain is 0-0.5 mm.

**Chain position**

Smallest sprocket      Largest chainring

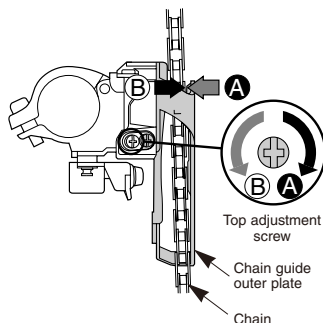

#### 4. Adjustment of the intermediate chainring

When carrying out adjustment, set the chain to the largest sprocket, and at the front, set the chain to the intermediate chainring. Adjust using the outer casing adjustment barrel so that the clearance between the chain guide inner plate and the chain is 0-0.5 mm.

##### Chain position

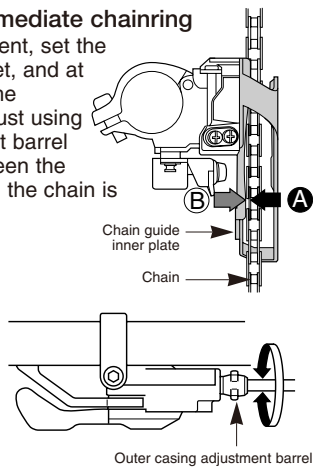
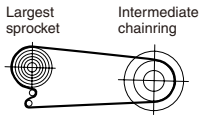

#### 5. Troubleshooting chart

After completion of steps 1 - 4, move the shifting lever to check the shifting. (This also applies if shifting becomes difficult during use.)

If the chain falls to the crank side.	Tighten the top adjustment screw clockwise (about 1/4 turn).
If shifting is difficult from the intermediate chainring to the largest chainring.	Loosen the top adjustment screw counterclockwise (about 1/8 turn).
If shifting is difficult from the intermediate chainring to the smallest chainring.	Loosen the low adjustment screw counterclockwise (about 1/4 turn).
If there is interference between the chain and the front derailleur inner plate at the largest chainring.	Tighten the top adjustment screw clockwise (about 1/8 turn).
If there is interference between the chain and the front derailleur outer plate at the largest chainring.	Loosen the top adjustment screw counterclockwise (about 1/8 turn).
If the intermediate chainring is skipped when shifting from the largest chainring.	Loosen the outer casing adjustment barrel counterclockwise (1 or 2 turns).
If there is interference between the chain and front derailleur inner plate when the rear sprocket is shifted to the largest sprocket when the chainwheel is at the intermediate chainring position.	Tighten the outer casing adjustment barrel clockwise (1 or 2 turns).
If the chain falls to the bottom bracket side.	Tighten the low adjustment screw clockwise (about 1/2 turn).

## Replacement of the indicator

Disassembly and reassembly should only be carried out when replacing the indicator.

1. Remove the two indicator set screws which are securing the indicator.

**Tightening torque :**  
0.3 - 0.5 N·m {3 - 4 in. lbs.}

2. Remove the indicator unit as shown in the illustration.

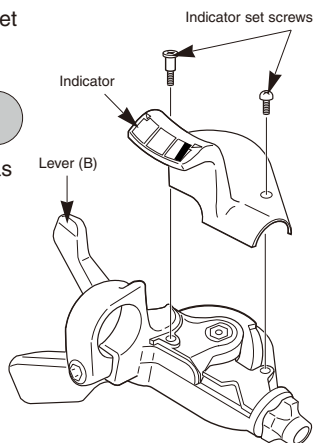

- Operate lever (B) two times or more to set the lever to the lowest position.
- After checking that the indicator needle is at the right edge, install the indicator from directly above.

SL-M510

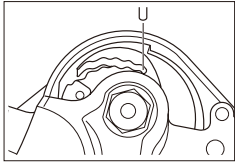

ST-M510

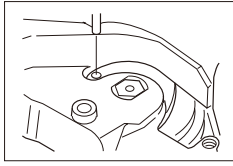

- Check the operation of the indicator. If it does not operate correctly, re-install the indicator by while taking particular note of steps 3. and 4.

Do not disassemble the indicator and shifting lever unit, as this may damage them or cause mis-operation.

## Gear shifting operation

Both lever (A) and lever (B) always return to the initial position when they are released after shifting.

When operating one of the levers, always be sure to turn the crank arm at the same time.

### To shift from a small chainring to a larger chainring

When lever (A) is pressed once, there is a shift of one step from a small chainring to a larger chainring.

#### Example:

from intermediate chainring to largest chainring.

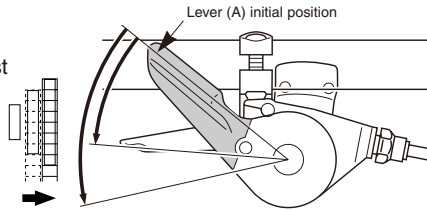

### To shift from a large chainring to a smaller chainring

When lever (B) is pressed once, there is a shift of one step from a large chainring to a smaller chainring.

#### Example:

from largest chainring to intermediate chainring.

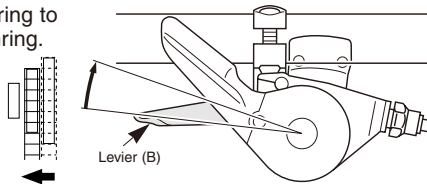

This service instruction explains how to use and maintain the Shimano bicycle parts which have been used on your new bicycle. For any questions regarding your bicycle or other matters which are not related to Shimano parts, please contact the place of purchase or the bicycle manufacturer.

## SHIMANO

### SHIMANO AMERICAN CORPORATION

One Holland, Irvine, California 92618, U.S.A. Phone: +1-949-951-5003

### SHIMANO EUROPE HOLDING B.V.

Industrieweg 24, 8071 CT Nunspeet, The Netherlands Phone: +31-341-272222

### SHIMANO INC.

3-77 Oimatsu-cho, Sakai, Osaka 590-8577, Japan

Please note: specifications are subject to change for improvement without notice. (English)  
© Sep. 2003 by Shimano Inc. XBC SZK Printed in China

